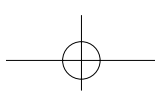

TABLE OF CONTENTS

	Page
1. INTRODUCTION	2
2. WARRANTY	2
3. MATERIAL AND SPECIFICATION	3-4
3-1 GENERAL ELASTOMER INFORMATION	3
3-2 METAL CASE AND SPRING	4
4. SEAL DESIGN	5-7
4-1 STANDARD LIP AND CASE DESIGN	5
4-2 SPECIAL LIP AND CASE DESIGN	6
4-3 MFC SPECIAL HELIX DESIGN	7
4-4 STANDARD OIL SEAL TOLERANCE	7
5. INSPECTION STANDARD	8-9
5-1 TYPICAL OIL SEALS IMPERFECTIONS	8
5-2 SAMPLING PLAN	9
6. SHAFT INSTALLATION AND RECOMMENDATION	10-13
7. HOUSING INSTALLATION AND RECOMMENDATION	14-15
8. GUIDELINE FOR FITTING SEAL	16
9. SIZE LIST	17-50
9-1 OIL BATH SEAL	17-18
9-2 SCREW CAP	19
9-3 WIPER SEAL	20
9-4 OIL SEAL	21-49
9-5 VALVE STEM SEAL	50
9-6 BONDED SEAL	51

NOTE:SIZE LIST FOR AUTOMOTIVE AND INDUSTRIAL SEALS ARE AVAILABLE ON REQUEST



1. INTRODUCTION

For over 20 years experience, MFC supplies high level radial lip oil seals successfully. This catalogue provides essential information of selection and application for users. We hope this catalogue will be useful in leading you to the selection of correct MFC seal for your application.

Due to the fact that the size list for general industries and vehicles is very vast and involve many different kinds of types, therefore we do not include them in this catalogue. As new sizes are adding continuously, and if you have the need please contact our sales person for standard sizes list, stock list and tooling list available. The appropriate individuals will be pleased to assist you.

2. WARRANTY

MFC, warrants that all products sold shall be free from defects in material and workmanship for a period of one year from date of shipment. At our option, any products prove unable to meet the sealing and design capabilities for which it was produced shall be replaced free of charge including transportation charges, but not the cost of installation, providing that the products are not subject to negligence, accident, or damages beyond our control. All other warranties, expressed or implied, including warranty of merchantability, are hereby disclaimed. We shall not be responsible for consequential damages.

3. MATERIALS AND SPECIFICATIONS

The most important component of oil seals is the elastomer material. You must consider about the environmental conditions and the functions of the seal as following:

- | | |
|---|---------------------|
| Good chemical resistance | Low compression set |
| Good resistance to heat and low temperature | Good elasticity |
| Good resistance to ozone and weathering | Raw material cost |
| High resistance to water | |

In order to satisfy various sealing conditions, followings are compounds available for your choice.

3-1 GENERAL ELASTOMER INFORMATION

TABLE 1

BASE POLYMER	NITRILE (NBR)	POLYACRYLATE (ACM,PA)	SILICONE (MVQ)	FLUROELASTOMER (FKM, FPM)	HNBR	EPDM
Material code	N	P	S	V	HN	E
TEMPERATURE RANGE*	-40° F-250° F -40° C-120° C	-5° F-300° F -20° C-150° C	-80° F-440° F -60° C-225° C	-5° F-527° F -20° C-275° C	-40° F-300° F -40° C-150° C	-60° F-250° F -50° C-120° C
Oil Resistance	E	E	G	E	E	F
Acid Resistance	G	F	F	E	G	G
Alkali Resistance	G	X	X	F	G	G
Water Resistance	G	F	G	G	G	E
Heat Resistance	G	E	E	E	G	G
Cold Resistance	G	F	E	F	G	G
Wear Resistance	E	E	G	E	E	E
Ozone Resistance	G	E	E	E	G	E
Engine Oil	E	E	G	E	E	X
Gear Oil	G	G	X	E	G	X
Turbine Oil No.2	G	G	G	E	G	X
Machine Oil No.2	G	G	F	E	G	X
Automatic Transmission Fluid	E	E	F	E	E	X
Petroleum Base Lubricating Oil	E	E	F	E	E	X
Gasoline	F	X	X	E	G	X
Light Oil/Kerosene	F	X	X	G	G	X
Cutting Oil	E	G	F	E	E	X
Grease	E	E	E	E	E	X
E.P.Lubricants	G	E	X	E	G	X
Water-Glycol	E	X	G	G	E	E
Alcohol	E	X	G	F	E	E
20% Hydrochloric Acid Solution	F	F	F	E	F	F
30% Sulfuric Acid Solution	F	F	X	E	F	G
ASTM D2000 Spec.	M2BG710A14B14 EA14E014E034EF11EF21	M3DH708A26 B16E016E036	M7GE705A19B37 EA14E016E036F19	M4HK710A1-11 B38EF31E016E036	M3DH710A26 B36E016E036	M4CA710A25 B35EA14

- E Excellent
G Good for most applications
F Fair, can be used if no other materials available
X Not recommended
- Phosphate Ester and Water Glycol hydraulic fluids are not included in the Table.
- Water resistance includes steam. No material is ideally compatible as lubricity of water is very good
- PTFE, Ethylene Acrylate, and other elastomers are available.

TABLE 2

	Advantages:	Disadvantages:
NITRILE (NBR)	Commonly referred to as Buna-N or NBR and is copolymer of Butadiene and Acrylonitrile. Good resistance to petroleum oils, water, silicone oils, greases, glycol base fluids. Good abrasion resistance, cold flow, tear resistance.	Poor resistance to ozone and weather aging.
POLYACRYLATE (ACM , PA)	Polymerised acrylic acidesters or PA and ACM. Good resistance to mineral oils, hypoid gear oils E.P. additives, greases, aging and flex cracking.	Poor cold temperature limit, dry running ability, water resistance. Lower mechanical strength.
FLUOROELASTOMER (FKM , FPM)	Good temperature resistance. Commonly chosen as high temperature replacement for Nitrile or Polyacrylate.	Fair resistance to water, dry running. Low temperature resistance is fair.
SILICONE (MVQ)	Broad temperature range. Good ozone resistance. Resistant to compression set.	Low resistance to hydrocarbon fluids like gasoline or paraffin fluids or steam above to 50 psi.
HNBR	HNBR is a highly saturated nitrile, which exhibits better wear resistance than standard nitrile. It exhibits excellent abrasion, compression set, tensile and tear resistance. Unlike standard nitriles, HNBR exhibits resistance to ozone, sunlight, and other atmospheric conditions. It also exhibits vastly improved resistance to heat aging in the 300° F range and, for short periods, up to 350° F. presently available material exhibits a low temperature to -40° F.	No recommended for exposure to ketone esters, aromatic fluid.
EPDM	EPDM is good weather aging and ozone resistance. And it exhibits excellent to phosphate ester fluid, automotive brake fluid and steam. Good in ketones and alcohols.	Poor resistance to mineral oils. And not recommended for exposure to aromatic hydrocarbons.

* Maximum temperature limits depend on other operating conditions.

3-2 METAL CASE AND SPRING

The other major components of oil seals are the metal case and garter spring. Table 3 lists the material specifications that MFC applies for its components.

TABLE 3

CASE				
SAE NO.	AISI NO.	APPLICATION	COST	SUGGESTION
1008-1010	1008-1010	General	Low	
30304	304	Special corrosion Resistance condition	High	By using a fully rubber covered design with carbon steel case can reduce cost.

SPRING				
SAE NO.	AISI NO.	APPLICATION	COST	
1070-1080	1070-1080	General	Low	
30304	304	Special corrosion Resistance condition	High	

The metal case is produced from carbon steel for applications in oil or grease. For special applications in sealing sea water or corrosive fluids, stainless steel with high cost can be used. In sealing applications for water, cost may be reduced by using a rubber covered design with carbon steel case. The garter spring, made of piano wire, is used for general applications. If corrosion resistance or extreme heat resistance is required, stainless steel wire is the appropriate material.

4. SEAL DESIGN

4-1 STANDARD LIP AND CASE DESIGN

Generally, seals with spring loaded lips are used for retaining oil lubricants and non-spring loaded lips are used for low speed grease retention. Ground metal O.D. seals are more suited for steel and cast iron housing. Rubber O.D. seals are more suited to soft alloy or plastic housing, for rough bore finishes above 100 μ inch (2.54 μ m), or for applications where the housing is subject to large thermal expansion. A press fit metal O.D. seal has greater holding strength and better alignment.



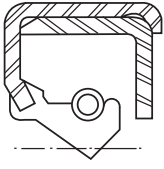
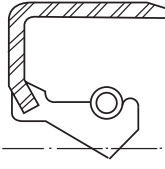
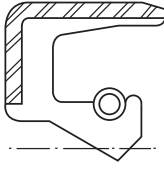
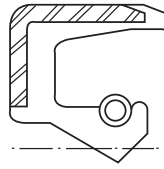
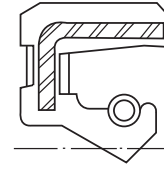
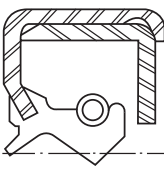
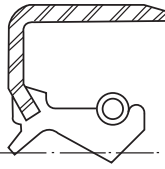
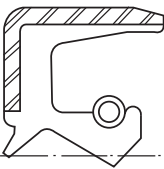
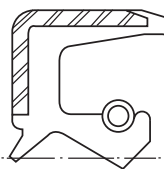
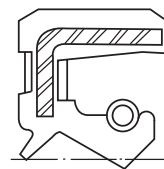
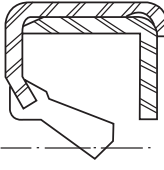
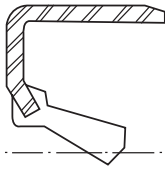
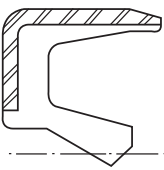
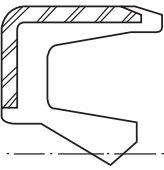
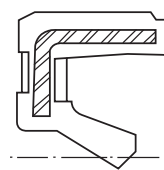
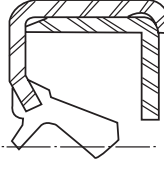
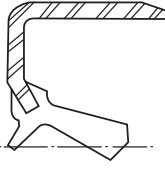
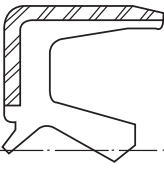
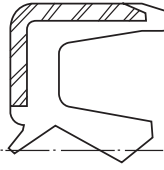
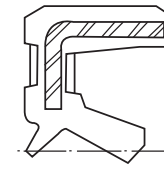







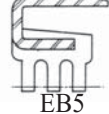
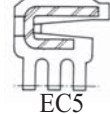







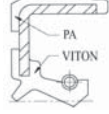
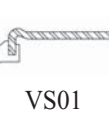
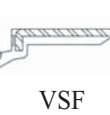





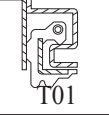
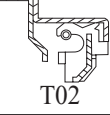

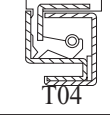

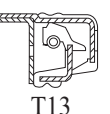



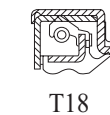

TABLE 4

CASE DESIGN		A	B	BF	BZ	C		
APPLICATION AND DESCRIPTION		Metal O.D. with an inner case for lip protection & greater structural rigidity.	Metal O.D. with ground surface and front chamfer. Most common & economical.	Metal O.D. with fully rubberized inner case.	Metal O.D. and nose gasket to seal against the bottom of the bore.	Rubber covered O.D. for improving O.D. sealing ability and for large thermal expansion of soft alloy or plastic housing.		
LIP DESIGN								
S	<ul style="list-style-type: none"> Single lip with a garter spring Low pressure fluids or serve grease sealing applications. If case A,B,C are used with backup ring, it can operate at medium pressure (up to 10 bar) 							
		SA1/SA	SB1/SB	SBF	SBZ	SC		
		T	<ul style="list-style-type: none"> Dual lips with garter spring. Low pressure conditions with high dirt exclusion foreign materials and serve grease sealing applications. Shaft surface speed <25 m/s (82ft/s) 					
				TA1/TA	TB1/TB	TBF	TBZ	TC
V	<ul style="list-style-type: none"> Single lip without garter spring. For sealing nonpressure medium especially for grease retention or sealing viscous fluid. Shaft surface speed <10 m/s (33ft/s) 							
				VA1/VA	VB1/VB	VBF	VBZ	VC
		K	<ul style="list-style-type: none"> Dual lips without garter spring. For sealing nonpressure medium especially for grease retention or sealing viscous fluid with light duty, dust exclusion. Shaft surface speed <10 m/s (33ft/s) 					
				KA1/KA	KB1/KB	KBF	KBZ	KC

4-2 SPECIAL LIP AND CASE DESIGN

The MFC product line is not limited to the seals listed in this catalogue. We are able to provide virtually any size and type of shaft seal.

TABLE 5

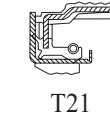
SPECIAL LIP DESIGN	APPLICATION	SEAL DESIGN				
D	<ul style="list-style-type: none"> Double lips with garter spring. Separating two fluids from each other such as ATF and gear oil. 	 DAZ	 DB	 DC	 DC01	
V	<ul style="list-style-type: none"> Corrugated rubber O.D. for large thermal expansion housing. Press fitting into a bore in an application where installation is difficult. 	 SCV	 TCV	 KVC	 VCV	
E	<ul style="list-style-type: none"> Triple flat lip design for used in heavy mud/dirt application at low rpm. Commonly used in disk harrows and other agricultural equipment. 	 EA	 EA5	 EB5	 EC5	
O	<ul style="list-style-type: none"> Like the standard seal design except with an external lip. Especially designed for a press fit on the shaft and to seal a rotating housing e.g truck wheel hub. 	 OKB	 OSB	 OSC	 OTC	
11/N	<ul style="list-style-type: none"> With extremely short flex section for medium pressure up to 50 psi(3.5 kg/cm). Ideal for small pump and machinery with pressurized cavities, e.g used in hydraulic, pump, oil pump...etc. 	 SB11	 TB11	 SCN	 TCN/TC23	
TC24	<ul style="list-style-type: none"> For high temperature engine crank shaft Lip material is Viton PA material for rubber covered O.D. 	 PA VITON				
VALVE SEAL	<ul style="list-style-type: none"> For high temperature engine application Available with the material PA and Viton 	 VS01	 VSF	 VSF01	More than 20 kinds of type are available depending on your requestment.	
PTFE	<ul style="list-style-type: none"> PTFE(Teflon) lip for sealing aggressive media and sealing area under high thermal stress. PTFE is bonded to the flexible rubber lip face. 	 DCY	 TAY	 TCY	 TC37Y	
OIL BATH SEAL	<ul style="list-style-type: none"> A seal special design for wheel hubs of truck, bus & tractor 	 T01	 T02	 T03	 T04	
		 T11	 T12	 T13	 T14	 T15
		 T16	 T17	 T18	 T19	 T21

4-3 MFC SPECIAL HELIX DESIGN

The use of a hydrodynamics aid or helix can improve the performance of the sealing lip. The helix is engraved on the primary lip and caused a pumping action to push any medium back towards the fluid side. There are designs available for bi-directional, left and right hand shaft rotations as below.

SPECIAL STYLE OF HELIX

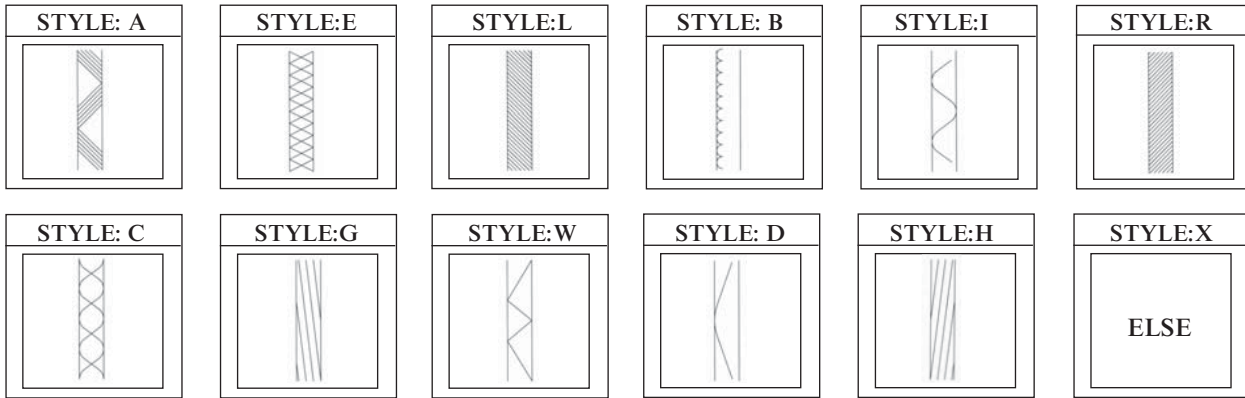

4-4 STANDARD OIL SEAL TOLERANCE

The recommended seal width tolerance are given in table 6.

TABLE 6 Seal width tolerance

Seal width <i>b</i>	Tolerance
$b < 10$	+/-0.2
$b > 10$	+/-0.3

To provide an interference fit between the seal outside surface and the housing bore surface, the recommended tolerances for the outside diameter of the seal shall be given as in table 7. (ISO 6194/1)

TABLE 7 Seal outside diameter tolerance

Nominal outside diameter <i>D</i>	Diametral tolerance		Roundness tolerance(1)	
	Metal cased	Rubber covered(2,3)	Metal cased	Rubber covered
$D \leq 50$	+0.20 +0.08	+0.30 +0.15	0.18	0.25
$50 < D1 \leq 80$	+0.23 +0.09	+0.35 +0.20	0.25	0.35
$80 < D1 \leq 120$	+0.25 +0.10	+0.35 +0.20	0.30	0.50
$120 < D1 \leq 180$	+0.28 +0.12	+0.45 +0.25	0.40	0.65
$180 < D1 \leq 300$	+0.35 +0.15	+0.45 +0.25	0.25% of out-side diameter	0.80
$300 < D1 \leq 440$	+0.45 +0.20	+0.55 +0.30	0.25% of out-side diameter	1.00

- (1) The roundness tolerance is equal to the difference between the maximum diameter and the minimum diameter derived from three or more equally spaced measurements.
- (2) Rubber-covered seals having a wave profile outside surface are acceptable but will require different tolerances to be agreed between manufacturer and purchaser.
- (3) Rubber-covered seals employing certain materials other than nitrile may require different tolerance to be agreed between manufacturer and purchaser.

5. INSPECTION STANDARD

5-1 TYPICAL OIL SEALS IMPERFECTIONS

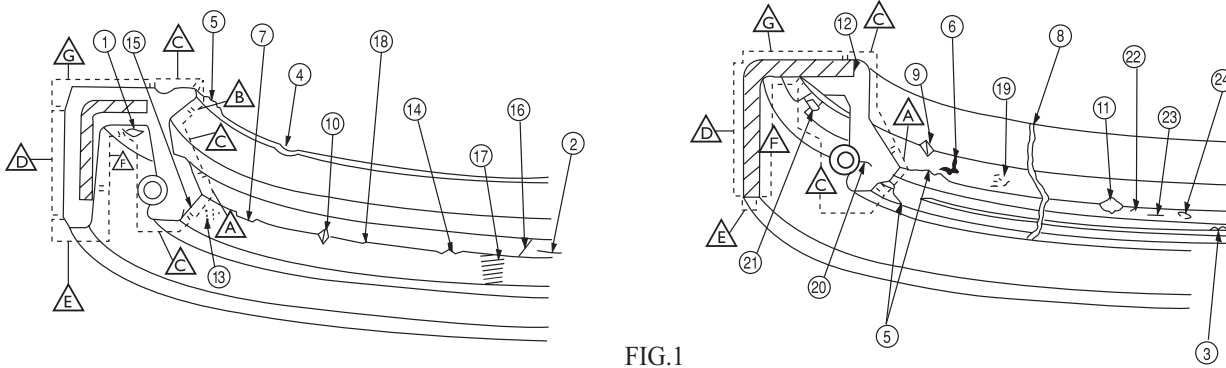

FIG.1

TABLE 8 Visual imperfection (see figure 1) (ISO 6194/2)

Item	Term	Definition	Critical	Minor
1	Blister	Hollow surface protrusion.	ABCDEG	F
2	Spilt	Tensile failure in the elastomer usually associated with a flow mark.	ABCDE	FG
3	Stuck flash	Flash which adheres to the main body of the seal.	ABCDEG	F
4	Deformation	Stress-induced change of form or shape.	ABCDE	FG
5	Flash	Thin extensions of the elastomer formed by extrusion at the parting lines in the mould cavity or vent points.	ABCDEG	F
6	Inclusion	Foreign matter included in the seal material.	ABCDE	FG
7	Incomplete trim	Trimmed surface which does not have all designated material removed.	AB	
8	Knit line; flow mark	Blemish of the sealing element created by premature curing during moulding operation.	ABCDE	FG
9	Mould imperfection	Moulded imperfection caused by damage to the mould surfaces.	ABCDE	FG
10	Nick	Localised loss of material due to damage after moulding.	ABCDE	FG
11	Nonfill	Randomly spaced irregularly shaped surface indentation caused by incomplete filling of the mould cavity.	ABCDE	FG
12	Bond failure	Lack of adhesion between the elastomer and the reinforcing materials.	CDEFG	
13	Porosity	Multitude of minute cavities within the elastomer.	ABCDE	FG
14	Rough trim	Trimmed surface with irregularities on the outside and inside lip surfaces in the immediate vicinity of the contact line.	AB	
15	Scoop trim	Trimmed surface which is concave.	AB	
16	Scratch	Shallow discontinuity on the seal caused by abrasive object passing over a surface.	ABCDE	FG
17	Spiral trim	Trimmed surface which shows a spiral pattern.	AB	
18	Step trim	Trimmed surface having step in the contact line.	AB	
19	Surface contamination	Foreign matter on the seal surface.	ABCDE	FG
20	Tear	Shear rupture of the elastomeric material, usually in the form of separation of a portion.	ABCDE	FG
21	Unbonded flash	Flash which does not properly adhere to the mating material to which it is intended to be bonded.	ABCDEF	G
22	Crack	Sharp break or fissure in the metal or elastomer.	ABCDE	FG
23	Cut	Relatively deep discontinuity in the seal material caused by a sharp instrument, whereby no material is removed.	ABCDE	FG

5-2 SAMPLING PLAN

- OUTER APPEARANCE
- SAMPLING PLAN

We use AQL 1.5 (C=0 sampling plan according to MIL 105E) for normal Oil Seal orders if no other sampling requirements.

For example: When order Q'ty is 700 pcs, 27 in 700 will be inspected. The 700-pc lot will be accepted only when no defective part in the sampled 27 pcs.

C=0 SAMPLING PLANS

INDEX VALUES

(ASSOCIATED AQL)

	.010	.015	.025	.040	.065	.10	.15	.25	.40	.65	1.0	1.5	2.5	4.0	6.5	10.0
LOT SIZE	SAMPLE SIZE															
2 to 8	*	*	*	*	*	*	*	*	*	*	*	*	5	3	2	2
9 to 15	*	*	*	*	*	*	*	*	*	*	13	8	5	3	2	2
16 to 25	*	*	*	*	*	*	*	*	*	20	13	8	5	3	3	2
26 to 50	*	*	*	*	*	*	*	*	32	20	13	8	5	5	5	3
51 to 90	*	*	*	*	*	*	80	50	32	20	13	8	7	6	5	4
91 to 150	*	*	*	*	*	125	80	50	32	20	13	12	11	7	6	5
151 to 280	*	*	*	*	200	125	80	50	32	20	20	19	13	10	7	6
281 to 500	*	*	*	315	200	125	80	50	48	47	29	21	16	11	9	7
501 to 1,200	*	800	500	315	200	125	80	75	73	47	34	27	19	15	11	8
1,201 to 3,200	1250	800	500	315	200	125	120	116	73	53	42	35	23	18	13	9
3,201 to 10,000	1250	800	500	315	200	192	189	116	86	68	50	38	29	22	15	9
10,001 to 35,000	1250	800	500	315	300	294	189	135	108	77	60	46	35	29	15	9
35,001 to 150,000	1250	800	500	490	476	294	218	170	123	96	74	56	40	29	15	9
150,001 to 500,000	1250	800	750	715	476	345	270	200	156	119	90	64	40	29	15	9
Up to 500,000	1250	1200	1112	715	556	435	303	244	189	143	102	64	40	29	15	9

The sign “*” indicate entire lot must be inspected

NOTE: The Acceptance Number in all cases is ZERO

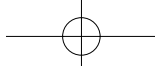

6.SHAFT INSTALLATION AND RECOMMENDATION

6-1 SHAFT INSTALLATION

During shaft seal installation, manufacturers instructions as well as the following guidelines should be observed. Silicone rubber WDR seals (radial shaft seals) need special attention because of their low impact strength.

Sealing lips must always face the medium to be sealed. The lips should be absolutely free and never tilted or pinched. Seal lip contact area on the shaft should be smooth and must be defect free.

In order to avoid damage during assembly the shaft should be radiused as per fig.2 when assembling the shaft in direction "z" and chamfered to the diameter given in table 9 when assembling in direction "y". This precaution also assists in centralizing the seal and preventing tipping.

When assembling the seal "lip first" to a shaft having no lead-in chamfer, a conical assembly sleeve should be used. The sealing edge should be similarly protected by an assembly sleeve when fitting the seal over grooves or splines(fig.3)

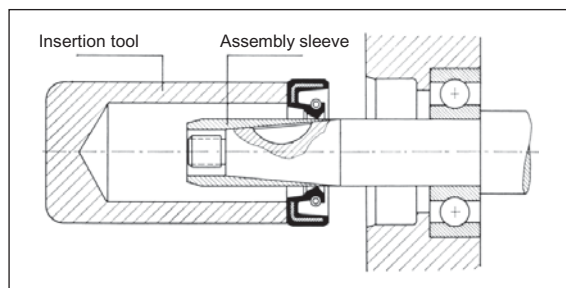

FIG 3.

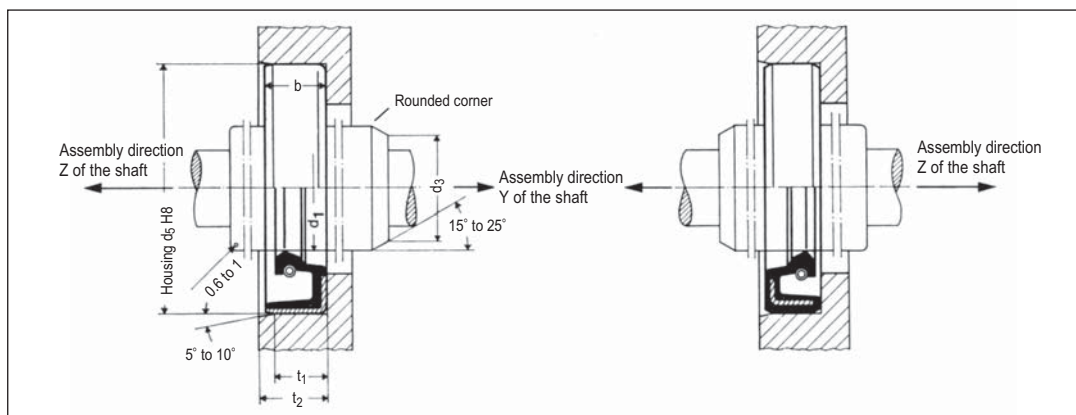

FIG 2.

TABLE 9

d ₁ h11	d ₃	d ₁ h11	d ₃	d ₁ h11	d ₃	d ₁ h11	d ₃	d ₁ h11	d ₃	d ₁ h11	d ₃
6	4,8	24	21,5	52	48,3	85	80,4	160	153	340	329
7	5,7	25	22,5	55	51,3	90	85,3	170	163	360	349
8	6,6	26	23,4	56	52,3	95	90,1	180	173	380	369
9	7,5	28	25,3	58	54,2	100	95	190	183	400	389
10	8,4	30	27,3	60	56,1	105	99,9	200	193	420	409
11	9,3	32	29,2	62	58,1	110	104,7	210	203	440	429
12	10,2	35	32	63	59,1	115	109,6	220	213	460	449
14	12,1	36	33	65	61	120	114,5	230	223	480	469
15	13,1	38	34,9	68	63,9	125	119,4	240	233	500	489
16	14	40	36,8	70	65,8	130	124,3	250	243		
17	14,9	42	38,7	72	67,7	135	129,2	260	249		
18	15,8	45	41,6	75	70,7	140	133	280	269		
20	17,7	48	44,5	78	73,6	145	138	300	289		
22	19,6	50	46,4	80	75,5	150	143	320	309		

6-2 SHAFT RECOMMENDATION

The sealed shaft should fulfill the following requirements for a reliable and long service life seal.

6-2-1 SHAFT MATERIAL

Seals perform best on a medium carbon steel or stainless steel shaft. Heat treatment or nitriding is especially recommended. To seal water at low surface velocity, stainless steel is more suitable.

6-2-2 SHAFT SURFACE HARDNESS

The effective life of the seal depends on the surface hardness of the shaft in the sealing zone. This should have a hardness of at least 45 HRC.

Where lubrication is doubtful, abrasive matter is present or shaft speed is greater than 14m/sec., 55 HRC is preferred.

When the shaft is superficially hardened, this must be done to a minimum depth of 0.3 mm.

If nitriding is used, the surface must be polished.

6-2-3 SHAFT SPEED

The shaft speed corresponding to lip material is referred to in fig.4 and table 10.

6-2-4 SHAFT SURFACE ROUGHNESS

The recommended shaft surface roughness is as follow:

Rotating: 10 to 20 μ inch RA (.25 μ m to .50 μ m RA)

Reciprocating: 5 to 10 μ inch RA (.13 μ m to .25 μ m RA)

This is very critical as greatly influence the amount of the lip heat, thus this finish should not be overlooked.

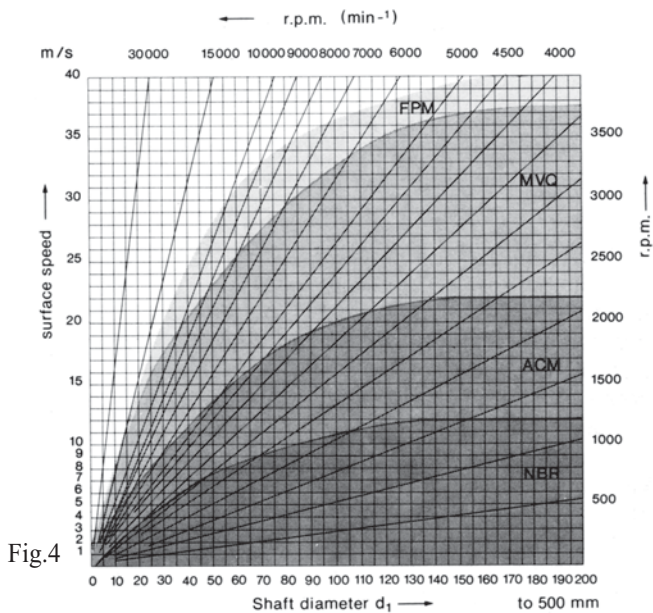

Fig.4

TABLE 10

Sealed Media																							
Basic Polymer		Media based on mineral oil														Other Media							
		Low temperature properties °C		Motor oil		Gear oil		Auto transmission fluids		Hypoid gear oil		Grease		Heating oil		Pressure fluids (see VDMA 24318)		Water -Lye		highly-inflam-mable pressure fluids, HSA, HSB, HSC, (see VDMA 24317)		Air	
		RWDR-Wert ⁴⁾	DTA ⁵⁾	T _D ¹⁾	T _M ²⁾	T _D	T _M	T _D	T _M	T _D	T _M	T _D	T _M	T _D	T _M	T _D	T _M	T _D	T _M	T _D	T _M		
NBR		-40	-20 to -40	90	130	90	120	100	120	80	100	90	130	90	130	90	130	90	120	—	—	110	150
ACM		-30	-20 to -30	130	160	125	160	120	150	125	150	110	150	.	.	120	150	—	—	—	—	140	180
MVQ ³⁾		-50	≤-45	140	170	—	—	130	150	—	—	—	—	—	—	.	.	—	—	.	.	180	220
FPM		-40	-20 to -30	150	180	150	170	150	180	140	160	150	180	150	180	150	180	110	150	150	180	230	300

1) T_D: max. allowable continuous temperature at sealing lip.

2) T_M: max. allowable peak temperature. Total ≤ 10 hours.

3) Silicone only usable when open access to air flow.

4) RWDR-Wert: Temperature at which the seal remains effective.

5) DTA=Glass point T_R from DIN 53545.

6-2-5 SHAFT GRINDING

Rotating shaft: plunge grinding is recommended.
 Reciprocating shaft: centerless grinding is acceptable.
 Cast iron or stainless steel shafts for rotating applications and steel shafts for reciprocating applications, we suggest using hard chrome plating.
 The finishing surfaces described above are required to have no machine lead, otherwise it may actually pump from wider the seal lip.

6-2-6 SHAFT CHAMFER

Without proper chamfer on shaft, the seal lip may be damaged or distorted or resulting from dislodged garter spring. We suggest chamfer as table 11 to assist in the application process.

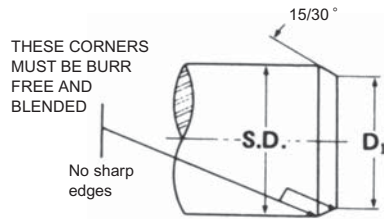

Table 11 RECOMMENDED SHAFT CHAMFER

INCHES				MILLIMETERS			
S.D.	D1	S.D.	D1	S.D.	D1	S.D.	D1
Up to 1.000	S.D.-.094	4.001 to 5.000	S.D.-.220	Up to 25.00	S.D.-2.4	100.01 to 125.00	S.D.-5.6
1.001 to 2.000	S.D.-.140	5.001 to 6.000	S.D.-.260	25.01 to 50.00	S.D.-3.6	125.01 to 150.00	S.D.-6.6
2.001 to 3.000	S.D.-.166	6.001 to 10.000	S.D.-.276	50.01 to 75.00	S.D.-4.2	150.01 to 250.00	S.D.-7.0
3.001 to 4.000	S.D.-.196	--	--	75.01 to 100.00	S.D.-5.0	--	--

Fig.5- Shaft Runout

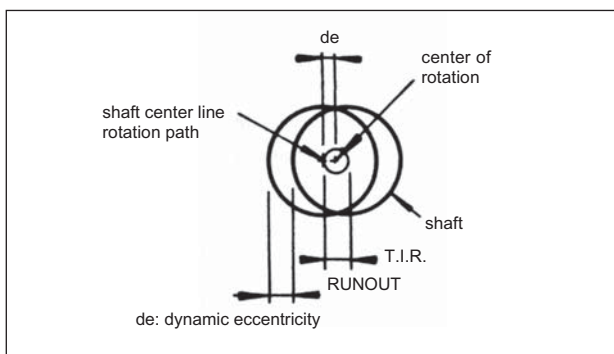
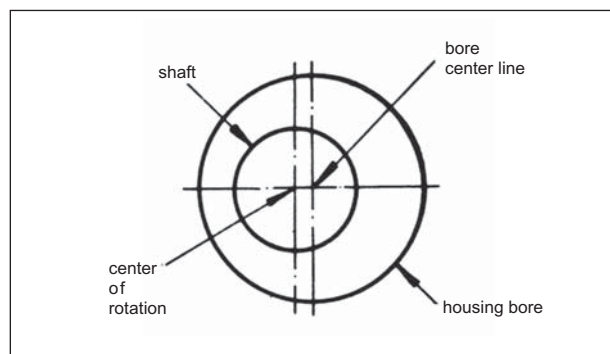

Fig.6- Shaft Offset



6-2-7 SHAFT TOLERANCE

The tolerance range should be decreased for high speed or pressure applications (Table 12).

Table 12

DIAMETER INCH	TOLERANCE
UP TO 4.000"	+/- 0.03
4.001" TO 6.000"	+/- 0.04
6.001" TO 10.000"	+/- 0.05

DIAMETER METRIC	TOLERANCE
UP TO 100 mm	+/- 0.08
100.10 TO 150.00	+/- 0.10
150.10 TO 250.00	+/- 0.13

6-2-8 SHAFT ECCENTRICITY

Two types of shaft eccentricity affect seal performance. They are dynamic runout (doubt dynamic eccentricity) (fig.5) and offset (shaft to bore misalignment or static eccentricity)(fig.6). Please refer table. 13 and 14 for the allowable eccentricity.

Table 13 SEAL WITH SPRING

DESIGN LIMITATIONS

SHAFT DIAMETER	NITRILE LIP MAXIMUM CONTINUOUS SHAFT SPEED	MAXIMUM TOTAL ECCENTRICITY
General	3500 rpm	0.020"
0.500	7000 rpm	0.004"
1.500	6000 rpm	0.006"
2.500	4000 rpm	0.010"
3.500	3500 rpm	0.013"
4.500	2600 rpm	0.017"

NOTE : Higher shaft speed is possible using higher temperature materials such polyacrylate, fluoroelastomer or silicone.
Higher eccentricity is allowable if shaft speed is reduced.

Table 14 SEAL WITHOUT SPRING

DESIGN LIMITATIONS

SHAFT DIAMETER	MAXIMUM CONTINUOUS SHAFT SPEED	MAXIMUM TOTAL ECCENTRICITY
General	2000 rpm	0.005"
0.500	3500 rpm	0.003"
1.500	2500 rpm	0.005"
2.500	2100 rpm	0.006"
3.500	1500 rpm	0.008"
4.500	1200 rpm	0.010"

NOTE : Higher eccentricity is allowable if maximum shaft speed is reduced.

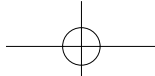

7. HOUSING INSTALLATION AND RECOMMENDATION

7-1 HOUSING INSTALLATION

The subject of installation represents an area commonly overlooked when selecting an oil seal for an application. Studies have shown this area to be one of the major causes of premature seal failure. To assist the installation, the oil seal should be prelubricated with grease or oil to reduce sliding friction of contact surfaces. This will also help protect the seal lips during initial run-in. This section explains on recommended procedures for installation.

Fig.7

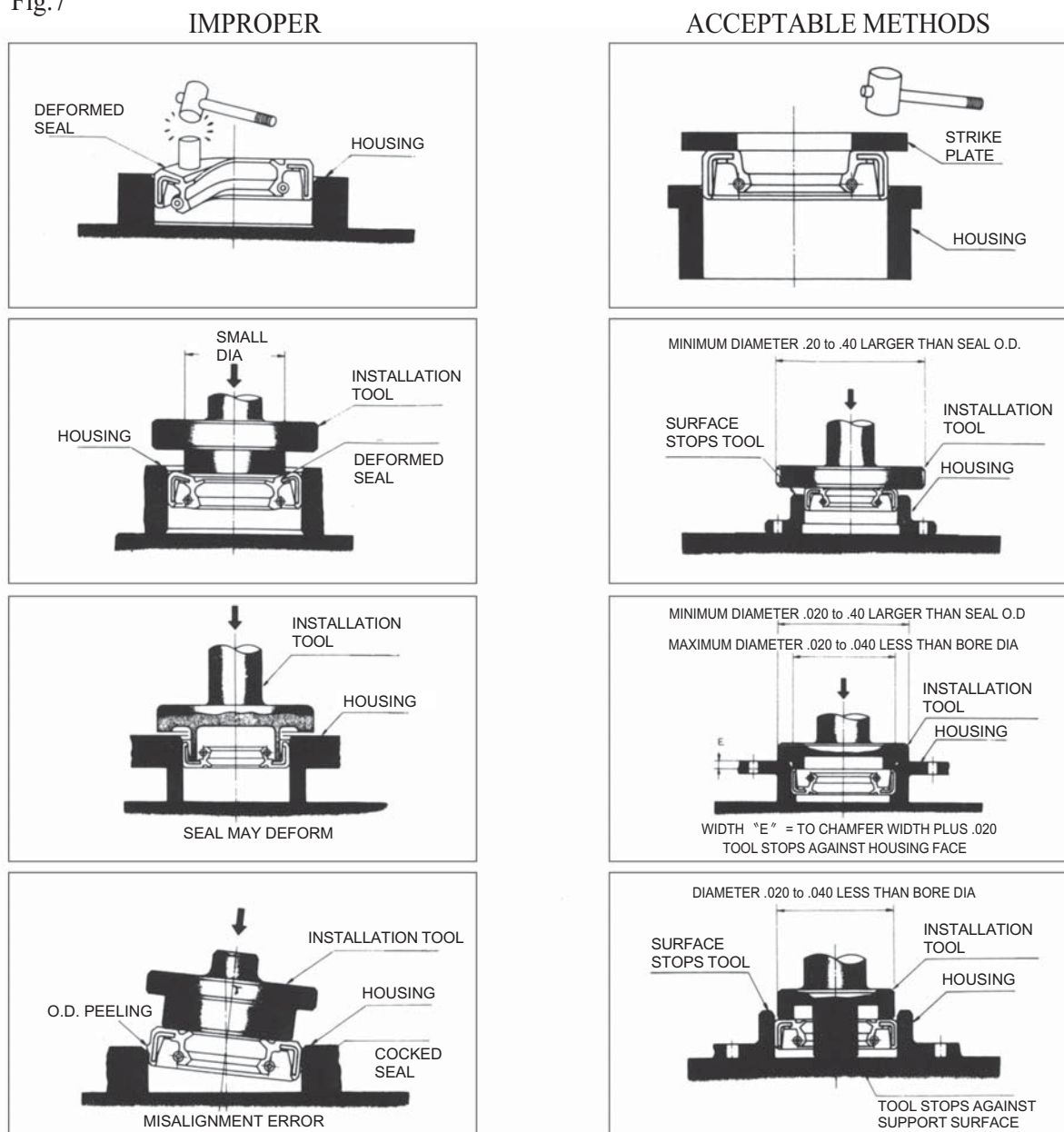

An installation tool should always be used when installing an oil seal. These use of a tool can make installation easier and lower the possibility of seal cooking. A hydraulic or pneumatic press is advised to supply necessary force to install the seal. Fig.7 describes example of both recommended and improper installation methods. In each preferred method, installation load is absorbed by either housing or bottom plate to prevent seal damage and to locate the seal properly within the bore.

7-2 HOUSING RECOMMENDATION

Which type of oil seal, either rubber covered seal or metal O.D.seal, is recommended depends upon the followings:

Housing material	Housing surface roughness
Bore chamfer	Housing tolerance

7-2-1 HOUSING MATERIAL

For rubber covered seals: steel and cast iron, soft alloy, aluminium alloy, plastic or nylon.

For metal cased seals: steel and cast iron

When applied to housing material of high thermal expansion, such as aluminium or other soft alloys, at temperature raising condition, metal cased seals occasionally back out of the bore due to expansion clearness. On the other hand, if we use rubber covered seals instead of metal cased ones, the clearness will vanish because of the higher thermal expansion rate of rubber itself.

7-2-2 BORE CHAMFER

To assist in installation of seals, a bore chamfer is necessary. If the chamfer is improper or not existing, it will distort seal case and required more assembly force.

7-2-3 HOUSING SURFACE ROUGHNESS

Excessively rough bore finishes may allow paths for fluids to leak between seal O.D. and bore. Following is recommended maximum roughness.

TABLE 15 HOUSING BORE ROUGHNESS

	METAL O.D.	RUBBER O.D.
MAXIMUM	100 μ inch AA	150 μ inch AA
ROUGHNESS	2.50 μ M AA	3.75 μ M AA

The rubber covered seal is capable of functioning with a rougher surface of housing.

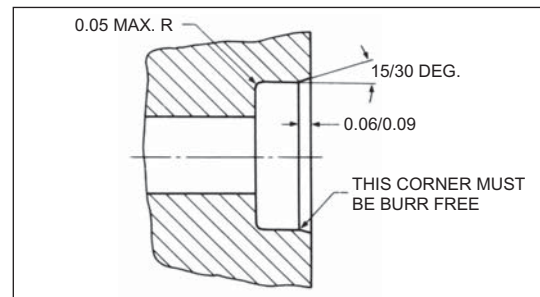

Figure 8 RECOMMENDED BORE LEAD CORNER

7-2-4 HOUSING TOLERANCE

Housing tolerances are in tables 16 and 17.

TABLE 16 Housing Tolerance in Inch

Bore diameter (inch)	Bore tolerance
Up to 3.000	+/-0.001
3.001 to 6.000	+/-0.0015
6.001 to 10.000	+/-0.002
10.001 to 20.000	+0.002/-0.004
20.001 to 40.000	+0.002/-0.006
40.001 to 60.000	+0.002/-0.010

TABLE 17 Housing Tolerance in Metric

Bore diameter (mm)	(ISO/H8)Bore tolerance
Over 6 to 10	+0.022/-0.000
Over 10 to 18	+0.027/-0.000
Over 18 to 30	+0.033/-0.000
Over 30 to 50	+0.039/-0.000
Over 50 to 80	+0.046/-0.000
Over 80 to 120	+0.054/-0.000
Over 120 to 180	+0.063/-0.000
Over 180 to 250	+0.072/-0.000
Over 250 to 315	+0.081/-0.000
Over 315 to 400	+0.089/-0.000
Over 400 to 500	+0.097/-0.000

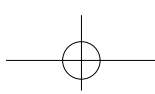

8. GUIDELINE FOR FITTING OIL SEAL

There is no doubt that the majority of failures and leakage of oil seals are due to careless fitting. In order to achieve goods results it is essential to follow rules listed as below.

1. Examine the seal before fitting, to ensure that it is clean and undamaged. If a spring is proved, check that it is correctly located.
2. Smear the sealing lip lightly with clean grease. Seals used as dust excluders should be packed with grease. If a seal of the dual type is being used, always pack the space between the elements with a good quality grease.
3. Make sure that the seal is mounted the correct way round. Normally the sealing lip (spring side) should face the fluid to be sealed.
4. It is important when fitting to see that the sealing lip is not damaged even by the slightest scratch, that the spring is correctly located when in position, and that the seal is properly pressed home into the housing recess.
5. If the housing is a heavy casting, do not allow the seal to rest on the shaft under its weight for any length of time as a permanent set may develop in the sealing element which will render it ineffective. This is vital in the case of synthetic rubber seals.
6. According to the type of assembly, it may be necessary either to press the seal into the housing first and subsequently enter the shaft, or firstly to pass the seal over the shaft and press it into the housing afterwards. It is preferable to mount the seal on the shaft first where circumstance permit, since this allows observation of the lip during the process. When passing the seal along the shaft, a slight rotary action will assist the operation.
7. Remove all abrasive matter or roughness over from shaft which the sealing lip is passed. Shaft edges or shoulders should be well rounded or chamfered, and where this is not practicable, a fitting sleeve with a lead-on taper and a diameter slightly greater than the shaft should be employed. The slightest scratch on the sealing edge of an oil seal may cause leakage and failure.
8. We recommend the use of an arbor press in combination with a suitable tool when mounting the seal into the housing. The diameter of the tool should be slightly less than the diameter of the housing, e.g., 0.1-0.4 mm smaller. Ensure that the seal enters the housing squarely.

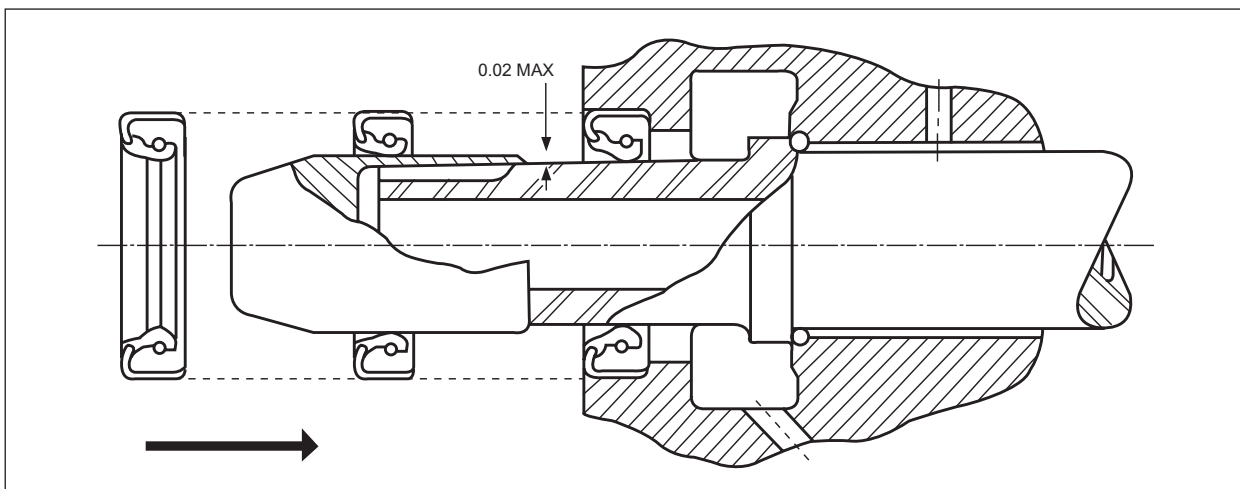

FIG 9.

3. Make sure that the seal is mounted the correct way round. Normally the sealing lip (spring side) should face the fluid to be sealed.
4. It is important when fitting to see that the sealing lip is not damaged even by the slightest scratch, that the spring is correctly located when in position, and that the seal is properly pressed home into the housing recess.
5. If the housing is a heavy casting, do not allow the seal to rest on the shaft under its weight for any length of time as a permanent set may develop in the sealing element which will render it ineffective. This is vital in the case of synthetic rubber seals.
6. According to the type of assembly, it may be necessary either to press the seal into the housing first and subsequently enter the shaft, or firstly to pass the seal over the shaft and press it into the housing afterwards. It is preferable to mount the seal on the shaft first where circumstance permit, since this allows observation of the lip during the process. When passing the seal along the shaft, a slight rotary action will assist the operation.
7. Remove all abrasive matter or roughness over from shaft which the sealing lip is passed. Shaft edges or shoulders should be well rounded or chamfered, and where this is not practicable, a fitting sleeve with a lead-on taper and a diameter slightly greater than the shaft should be employed. The slightest scratch on the sealing edge of an oil seal may cause leakage and failure.
8. We recommend the use of an arbor press in combination with a suitable tool when mounting the seal into the housing. The diameter of the tool should be slightly less than the diameter of the housing, e.g., 0.1-0.4 mm smaller. Ensure that the seal enters the housing squarely.

MFC OIL BATH SEAL STANDARD SIZE LIST

【IMPERIAL】

9-1 OIL BATH SEAL

NATIONAL		SHAFT DIA.	BORE DIA.	SEAL WIDTH.	MFC NO.	AVAILABLE TYPE	NATIONAL		SHAFT DIA.	BORE DIA.	SEAL WIDTH.	MFC NO.	AVAILABLE TYPE
SEAL	5 STAR GOLD						SEAL	5 STAR GOLD					
370001A	380001A	3.500	4.842	0.925	018	T01,T03,T04,T21	370064A		5.625	7.186	0.906	080	T01,T03,T04,T21
370002A		3.500	5.000	1.000	015	T01,T03,T04,T21	370065A	380065A	4.250	6.008	1.000	037	T01,T03,T04,T21
370003A	380003A	4.765	6.311	1.187	059	T01,T03,T04,T21	370066A		4.000	5.626	0.605	029	T01,T03,T04,T21
370004A		4.812	6.500	0.865	065	T01,T03,T04,T21	370069A		5.250	7.375	1.000	076	T01,T03,T04,T21
370005A		4.765	6.251	0.605	063	T01,T03,T04,T21	370069A		5.250	7.375	1.000	121	T01,T03,T04,T21
370006A		4.765	6.999	1.250	061	T01,T03,T04,T21	370077A		6.000	7.875	0.605	082	T01,T03,T04,T21
370007A		4.875	6.373	0.921	070	T01,T03,T04,T21	370078A		4.500	6.622	1.093	049	T01,T03,T04,T21
370008A		3.937	5.372	1.015	027	T01,T03,T04,T21	370082A		7.375	9.054	1.062	086	T01,T03,T04,T21
370009A		3.937	5.501	0.875	028	T01,T03,T04,T21	370086A		4.500	6.310	1.175	051	T01,T03,T04,T21
370010A		2.875	4.125	0.842	006	T01,T03,T04,T21	370087A		4.000	5.248	0.605	030	T01,T03,T04,T21
370011A		3.625	5.000	0.875	022	T01,T03,T04,T21	370093A		2.875	4.250	0.605	005	T01,T03,T04,T21
370012A		3.625	4.810	0.921	021	T01,T03,T04,T21	370094A		4.125	5.375	0.605	034	T01,T03,T04,T21
370013A		3.312	5.000	0.937	013	T01,T03,T04,T21	370106A		4.166	5.500	0.605	035	T01,T03,T04,T21
370014A		3.125	4.500	0.605	009	T01,T03,T04,T21	370107A		4.250	6.035	0.915	038	T01,T03,T04,T21
370015A		4.000	5.375	1.000	031	T01,T03,T04,T21	370109A		4.875	6.622	1.000	067	T01,T03,T04,T21
370018A		3.250	4.500	0.605	011	T01,T03,T04,T21	370119A		5.640	7.501	0.605	081	T01,T03,T04,T21
370019A		4.375	6.251	0.605	046	T01,T03,T04,T21	370120A		5.500	7.250	1.187	079	T01,T03,T04,T21
370020A		4.500	6.000	0.984	054	T01,T03,T04,T21	370121A		4.875	6.500	1.000	069	T01,T03,T04,T21
370021A		4.500	6.251	1.047	053	T01,T03,T04,T21	370124A		4.500	5.374	0.984	048	T01,T03,T04,T21
370022A	380022A	4.500	5.750	0.960	052	T01,T03,T04,T21	370127A		2.752	3.937	0.565	002	T01,T03,T04,T21
370023A	380023A	3.875	5.690	0.875	023	T01,T03,T04,T21	370131A	380131A	4.500	5.876	0.984	050	T01,T03,T04,T21
370023A	380023A	3.875	5.691	0.938	104	T01,T03,T04,T21	370132A		3.500	4.543	0.788	017	T01,T03,T04,T21
370024A		3.875	5.501	0.890	025	T01,T03,T04,T21	370145A		3.125	4.174	0.500	008	T01,T03,T04,T21
370025A	380025A	4.625	5.999	1.000	056	T01,T03,T04,T21	370149A		6.625	8.007	0.605	084	T01,T03,T04,T21
370026A		4.635	6.007	0.937	058	T01,T03,T04,T21	370150A		2.875	3.875	0.414	112	T01,T03,T04,T21
370027A		4.812	6.311	1.062	064	T01,T03,T04,T21	370151A		7.875	10.234	0.605	087	T01,T03,T04,T21
370028A		5.000	6.250	1.375	075	T01,T03,T04,T21	370154A		5.000	7.000	1.000	071	T01,T03,T04,T21
370029A		3.187	5.000	0.765	010	T01,T03,T04,T21	370155A		2.740	3.937	0.565	001	T01,T03,T04,T21
370030A		4.265	6.064	0.605	040	T01,T03,T04,T21	370165A		3.875	5.376	1.000	024	T01,T03,T04,T21
370031A	380031A	4.250	6.250	1.375	036	T01,T03,T04,T21	370166A		5.000	6.622	1.093	073	T01,T03,T04,T21
370031A	380031A	4.250	6.253	1.250	119	T01,T03,T04,T21	370169A		3.500	4.751	0.605	020	T01,T03,T04,T21
370031A	380031A	4.250	6.250	1.375	122	T01,T03,T04,T21	370173A		4.765	6.250	0.565	062	T01,T03,T04,T21
370033A		3.875	5.126	0.844	026	T01,T03,T04,T21	370175A		7.250	8.750	0.605	085	T01,T03,T04,T21
370034A		4.375	6.311	1.090	044	T01,T03,T04,T21	370178A		4.500	5.500	0.675	055	T01,T03,T04,T21
370036A	380036A	4.000	5.757	0.930	032	T01,T03,T04,T21	370179A		3.500	4.450	0.843	016	T01,T03,T04,T21
370037A		4.375	5.757	1.000	043	T01,T03,T04,T21	370181A		4.765	5.999	1.031	060	T01,T03,T04,T21
370038A		5.000	7.437	0.605	072	T01,T03,T04,T21	370182A		4.375	5.905	1.000	041	T01,T03,T04,T21
370039A		5.500	7.437	1.000	077	T01,T03,T04,T21	370189A		3.500	4.626	1.000	019	T01,T03,T04,T21
370043A		5.500	7.125	1.187	078	T01,T03,T04,T21	370191A		3.312	4.501	0.605	012	T01,T03,T04,T21
370046A		3.125	4.625	0.605	007	T01,T03,T04,T21	370192A		4.500	6.441	0.937	047	T01,T03,T04,T21
370047A		3.437	4.755	0.605	014	T01,T03,T04,T21	370195A		4.875	6.001	0.625	068	T01,T03,T04,T21
370048A	380048A	4.375	5.905	1.000	041	T01,T03,T04,T21	370338A		4.375	5.757	0.600	042	T01,T03,T04,T21
370051A		4.625	6.622	1.093	057	T01,T03,T04,T21	370349A		4.000	5.757	0.600	033	T01,T03,T04,T21
370054A		2.875	4.175	0.822	003	T01,T03,T04,T21	376590A		4.250	6.048	0.680	039	T01,T03,T04,T21
370057A		4.875	6.437	0.921	066	T01,T03,T04,T21	376856A		6.312	7.682	0.750	083	T01,T03,T04,T21
370063A		5.000	6.250	0.605	074	T01,T03,T04,T21							

ALL seals are pre-lubricated internationally

FOR CONFIGURATION PLEASE REFER TO "OIL BATH SEAL" ON PAGE 6

All seals are specially manufactured by MFC. The above information only functions as cross-reference.

【IMPERIAL】

9-1 OIL BATH SEAL

CR		SHAFT DIA.	BORE DIA.	SEAL WIDTH.	MFC NO.	AVAILABLE TYPE	CR		SHAFT DIA.	BORE DIA.	SEAL WIDTH.	MFC NO.	AVAILABLE TYPE
SEAL	SEAL PLUS						SEAL	SEAL PLUS					
28758		2.875	3.875	0.414	112	T02,T21	43752	43786	4.375	5.757	1.000	043	T02,T21
28820		2.875	4.125	0.842	006	T02,T21	43752	43786	4.375	5.757	0.600	042	T02,T21
28832		2.875	4.175	0.822	003	T02,T21	43764	43763	4.375	5.905	1.000	041	T02,T21
31175		3.125	4.174	0.500	008	T02,T21	43800		4.375	6.008	1.047	099	T02,T21
31281		3.125	4.500	0.605	009	T02,T21	43860	43861	4.375	6.251	0.605	046	T02,T21
31307		3.125	4.625	0.605	007	T02,T21	43875		4.375	6.311	1.090	044	T02,T21
32470		3.250	4.500	0.605	011	T02,T21	44922	44919	4.500	5.374	0.984	048	T02,T21
34387	34386	3.437	4.755	0.605	014	T02,T21	44964		4.500	5.500	0.675	055	T02,T21
34975		3.500	4.543	0.788	017	T02,T21	45010		4.500	5.500	0.675	055	T02,T21
35066	35059	3.500	4.842	0.925	018	T02,T21	45099	45097	4.500	5.750	0.960	052	T02,T21
35075		3.500	5.000	1.000	015	T02,T21	45103	45102	4.500	5.876	0.984	050	T02,T21
36285		3.625	4.810	0.921	021	T02,T21	45152		4.500	6.310	1.175	051	T02,T21
36365		3.625	5.000	0.875	022	T02,T21	45160	45158	4.500	6.251	1.047	053	T02,T21
38709		3.875	5.126	0.844	026	T02,T21	46305	46304/46300	4.625	5.999	1.000	056	T02,T21
38747		3.875	5.376	1.000	024	T02,T21	46390		4.635	6.007	0.937	058	T02,T21
38750		3.875	5.501	0.890	025	T02,T21	46396		4.625	6.622	1.093	057	T02,T21
38780	38779/38776	3.875	5.690	0.875	023	T02,T21	47697	47695/47692	4.765	6.311	1.187	059	T02,T21
38780	38779/38776	3.875	5.691	0.938	104	T02,T21	47699		4.765	6.999	1.250	061	T02,T21
39380		3.937	5.372	1.015	027	T02,T21	48000	48001	4.765	6.251	0.605	063	T02,T21
39420		3.937	5.501	0.875	028	T02,T21	48297		4.812	6.311	1.062	064	T02,T21
40040		4.000	5.375	1.000	031	T02,T21	48690		4.875	6.001	0.625	068	T02,T21
40086		4.000	5.626	0.605	029	T02,T21	48794		4.875	6.373	0.921	070	T02,T21
40136	40133	4.000	5.757	0.930	032	T02,T21	48796		4.875	6.437	0.921	066	T02,T21
40136	40133	4.000	5.757	0.600	033	T02,T21	48884		4.875	6.500	1.000	069	T02,T21
41550	42550	4.166	5.500	0.605	035	T02,T21	50124		5.000	6.250	1.375	075	T02,T21
42623	42622	4.250	6.008	1.000	037	T02,T21	52658		5.250	7.375	1.000	076	T02,T21
42624		4.250	6.035	0.915	038	T02,T21	52658		5.250	7.375	1.000	121	T02,T21
42672	42671	4.250	6.250	1.375	036	T02,T21	55172		5.500	7.125	1.187	078	T02,T21
42672	42671	4.250	6.253	1.250	119	T02,T21	56175		5.500	7.250	1.187	079	T02,T21
42672	42671	4.250	6.250	1.375	122	T02,T21	78790		7.875	10.234	0.605	087	T02,T21
42800		4.265	6.064	0.605	040	T02,T21	509425		7.250	8.750	0.605	085	T02,T21

MFC Axle Seal types interchange with following makers:

T01-National Type 370000 Series;

T02-CR Type Scot Seal;

T03-National Type 370000 Series;

T04-National Type 370000 Series;

T11-CFW Type RWDR-Kassette;

T12-STEFA Type 500;

T15-CFW Type RWDR-Kassette;

T17-MFC New Type;

T18-STEFA Type 500 with additional dirt protection;

T21-CR Type Scot Seal Plus;

ALL seals are pre-lubricated internationally

FOR CONFIGURATION PLEASE REFER TO "OIL BATH SEAL" ON PAGE 6

All seals are specially manufactured by MFC. The above information only functions as cross-reference.

MFC S19 STANDARD SIZE LIST

【METRIC】

9-2 SCREW CAP(S19,S91)

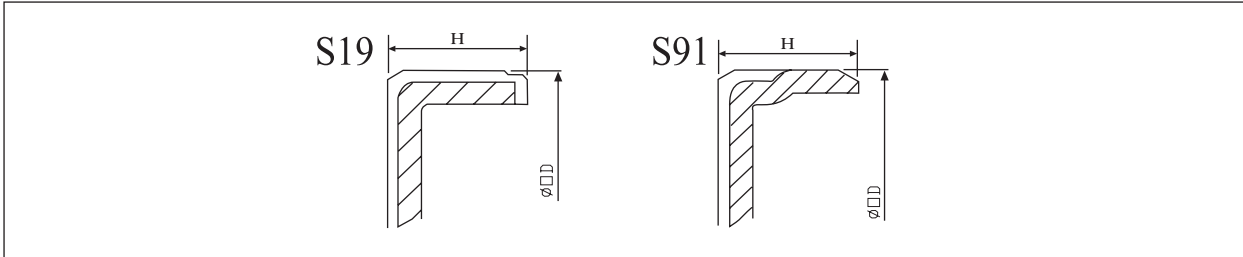

MFC NO.	NORMINAL SIZE	
	OD	H
S19001	16	4
S19005	26	6.5
S19006	28	7
S19007	28	9
S19008	30	6
S19011	35	8
S19013	40	7
S19017	47	10
S19019	50	10
S19020	52	6.5
S19021	52	10
S19022	55	10
S19023	60	10
S19025	65	10
S19027	72	9
S19028	75	7
S19032	80	10
S19033	80	12
S19034	85	12
S19039	120	12
S19040	125	12
S19044	160	15
S19048	32	7
S19059	47	7
S19063	42	7
S19069	52	7
S19072	62	7

MFC NO.	NORMINAL SIZE	
	OD	H
S19073	72	10
S19074	85	10
S19075	90	10
S19076	110	10
S19088	100	10
S19089	55	9
S19091	40	10
S19095	30	5
S19097	140	12
S19098	160	12
S19099	170	12
S19100	118	13.5
S19121	75	8
S19138	24	7
S19141	55	8
S19144	20	8
S19145	80	9
S19146	50	8
S19147	32	5
S19148	22	4
S19152	10	4
S19153	70	10
S19154	90	7
S19155	20	6
S19157	135	14
S19158	56	9

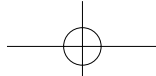

MFC W12 STANDARD SIZE LIST

【METRIC】

9-3 WIPER SEAL (W12)

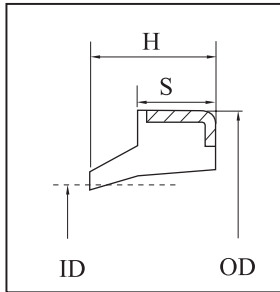

MFC NO.	NORMINAL SIZE				MFC NO.	NORMINAL SIZE			
	ID	OD	S	H		ID	OD	S	H
W12142	6	13	3	4.5	W12049	32	42	7	10
W12001	6	14	5	8	W12050	32	45	4	8
W12314	8	12.5	3	4.5	W12052	32	45	7	10
W12002	8	16	5	8	W12189	35	45	5	8
W12003	8	18	6	7.5	W12055	35	45	7	10
W12378	10	15	3	6	W12216	35	47	7	10
W12315	10	16	5	7	W12057	36	45	7	10
W12235	12	18	3.5	5	W12060	38	48	7	10
W12151	12	18	5	7	W12061	40	50	5	8
W12007	12	20	4	6	W12062	40	50	7	10
W12136	12	22	5	8	W12065	42	52	7	10
W12333	12	24	4	7	W12067	45	55	7	10
W12365	12.7	18	3	4.5	W12221	45	57	7	10
W12010	14	20	4	5	W12068	45	60	7	10
W12011	14	22	3	4	W12070	50	56	5	7
W12237	15	21	3.5	5	W12071	50	56	5	8
W12014	15	25	5	8	W12072	50	60	5	7
W12016	16	22	3	4	W12073	50	60	7	10
W12020	16	26	5	8	W12074	50	65	7	10
W12021	16	26	7	10	W12075	52	62	7	10
W12154	18	26	5	7	W12076	55	63	7	10
W12329	18	28	5	9	W12077	55	65	7	10
W12022	18	28	7	10	W12080	56	66	7	10
W12276	19	26	5	8	W12246	60	70	5	7
W12330	20	26	3.5	5	W12082	60	70	7	10
W12134	20	26	4	7	W12084	60	75	7	10
W12024	20	26	5	8	W12182	62	72	7	10
W12025	20	28	3.5	5	W12089	63	75	7	10
W12360	20	28	3.5	5.5	W12090	65	75	7	10
W12026	20	28	5	8	W12222	67	83	7	10
W12027	20	30	4	6	W12091	70	80	5	8
W12028	20	30	5	8	W12092	70	80	7	10
W12159	20	30	5	7	W12094	75	85	7	10
W12029	20	30	7	10	W12250	80	88	7	10
W12031	22	28	5	8	W12097	80	90	7	10
W12139	22	28	5	9	W12099	85	95	7	10
W12332	22	30	4	7	W12179	85	99	8	11
W12187	22	32	5	7	W12100	90	100	7	10
W12032	22	32	7	10	W12101	95	105	7	10
W12033	22	35	5	8	W12102	100	110	7	10
W12034	22	35	7	10	W12104	105	115	7	10
W12331	25	31	5	7	W12106	110	120	7	10
W12038	25	35	5	8	W12109	120	130	7	10
W12039	25	35	7	10	W12316	120	136	8	11
W12040	26	34	5	8	W12110	125	140	9	12
W12041	28	38	5	8	W12112	130	145	9	12
W12042	28	38	7	10	W12113	135	145	7	10
W12043	28	40	7	10	W12116	140	155	9	12
W12044	30	40	5	8	W12117	145	160	9	12
W12045	30	40	7	10	W12119	150	165	9	12
W12046	30	45	5	8	W12120	160	175	9	12
W12277	31.8	38	5	8	W12147	170	185	9	12
W12233	32	40	7	10	W12122	170	185	10	14
W12146	32	42	5	7	W12124	180	195	10	14

MFC OIL SEAL STANDARD SIZE LIST

【IMPERIAL】

9-4 OIL SEAL

ITEM NO.	ID	OD	H	TYPE	ITEM NO.	ID	OD	H	TYPE
SOA02720	0.125	0.500	0.125/0.188	KC7	SOA05993	0.560	0.960	0.280	TB1
SOA02720XX	0.125	0.500	0.125/0.188	KC7	SOA05068	0.562	0.937	0.313	SC
SOA00001	0.250	0.500	0.125	VC	SOA04015	0.562	1.000	0.250	SC31
SOA06884	0.250	0.505	0.190	VBF	SOA06913XX	0.562	1.000	0.302	SBF
SOA00002	0.250	0.750	0.250	SC	SOA11703XX	0.562	1.000	0.312	TA
SOA03571	0.250	0.750	0.250	SC25	SOA01533	0.562	1.378	0.250	TBZ
SOA05866XX	0.250	0.989	0.495	DC	SOA01531	0.562	1.558	0.250	TBZ
SOA03523XX	0.266	0.368	0.078	VC	SOA02399	0.583	1.382/1.506	0.189	TC37
SOA05580XX	0.312	0.630	0.275	TCN	SOA11504	0.593	1.124	0.312	TB
SOA03046XX	0.313	0.625	0.156	TB07	SOA01530	0.609	0.875	0.125	TBZ01
SOA05557	0.313	0.750	0.250	TCN	SOA01074XX	0.609	1.562	0.468	VCU01
SOA03685XX	0.321	0.882	0.250	SC02	SOA06191	0.624	0.937	0.170	VBF
SOA00011	0.375	0.750	0.250	SC	SOA03541	0.624	1.127	0.312	TC
SOA00011XX	0.375	0.750	0.250	SC	SOA01202	0.625	0.875	0.125	VB
SOA02236XX	0.422	0.875	0.312	SA07	SOA03042XX	0.625	0.875	0.157	SC17
SOA02657	0.432	0.650	0.100	VBF	SOA00044	0.625	0.937	0.187	SC
SOA06305XX	0.437	0.750	0.250	SBZ	SOA11512	0.625	1.000	0.125	VB
SOA04803XX	0.437	0.875	0.250	SBF	SOA03586XX	0.625	1.000	0.187	SCN
SOA02523	0.437	1.000	0.255	SBZ	SOA00048	0.625	1.000	0.250	SC
SOA05167XX	0.437	1.000	0.375	SB1	SOA03330	0.625	1.062	0.188	VB
SOA17803XX	0.468	0.875	0.312	SA1	SOA00052	0.625	1.125	0.375	SC
SOA06490	0.470	1.000	0.310	SBF	SOA03579	0.625	1.125	0.375	SA1
SOA03529	0.472	0.827	0.157	SC	SOA03690	0.625	1.125	0.375	SB
SOA03315	0.500	0.750	0.125	VB	SOA05675	0.625	1.128	0.375	TB11
SOA03334XX	0.500	0.750	0.125	VB1	SOA04006	0.625	1.250	0.250	TC
SOA05773	0.500	0.750	0.125	VBZ	SOA03697XX	0.625	1.375	0.250	SC
SOA11510	0.500	0.750	0.125	VCV	SOA06258	0.625	1.375	0.250	TA1
SOA11637	0.500	0.750	0.125	SBZ	SOA11557	0.650	1.125	0.562	TB
SOA17802XX	0.500	0.750	0.125	VA1	SOA03583	0.687	1.000	0.250	SC
SOA00770XX	0.500	0.750	0.168	SBF	SOA00905	0.687	1.125	0.250	TC
SOA04039	0.500	0.850	0.250	SC	SOA02710XX	0.687	1.250	0.250	TBZR
SOA00025	0.500	0.854	0.250	SB1	SOA11497	0.688	0.938	0.125	VBF
SOA01203	0.500	0.875	0.125	VB	SOA05602	0.688	0.938	0.172	VBF
SOA11511	0.500	0.875	0.125	VC	SOA02711XX	0.719	1.187	0.250	TC49
SOA00027	0.500	0.875	0.250	SC	SOA01204XX	0.750	1.000	0.125	VB
SOA03585	0.500	0.999	0.250	TBF	SOA02453	0.750	1.000	0.125	VBF
SOA03613	0.500	0.999	0.312	SBF	SOA02453XX	0.750	1.000	0.125	VBF
SOA00029	0.500	1.000	0.250	SC	SOA02673	0.750	1.000	0.125	KC
SOA02545	0.500	1.000	0.250	SB	SOA03019XX	0.750	1.000	0.125	KC
SOA02564	0.500	1.000	0.375	SB	SOA06986	0.750	1.124	0.156	VB1
SOA00031XX	0.500	1.125	0.250	SC	SOA00718	0.750	1.125	0.187	SC
SOA03578	0.500	1.125	0.375	SA1	SOA02365XX	0.750	1.125	0.188/0.235	SB07
SOA04854XX	0.500	1.375	0.250	SB1	SOA05256	0.750	1.125	0.250	SB1
SOA03507XX	0.531	0.755	0.125	VBZ	SOA03592	0.750	1.187	0.156	VB
SOA06586	0.560	0.930	0.310	SB	SOA03506	0.750	1.250	0.125	VBF

As the new tools adding continuously, please contact with our sales person for the newest tool list.

MFC OIL SEAL STANDARD SIZE LIST

【IMPERIAL】

ITEM NO.	ID	OD	H	TYPE	ITEM NO.	ID	OD	H	TYPE
SOA03506XX	0.750	1.250	0.125	VBF	SOA04420	0.906	1.177	0.156/0.256	SP14
SOA00073	0.750	1.250	0.250	SC	SOA04254	0.906	1.354	0.250	SC32
SOA00975	0.750	1.250	0.250	SBY	SOA01307	0.937	1.500	0.250	SB
SOA01602	0.750	1.312	0.312	TBZR	SOA00119	0.937	1.500	0.375	SC
SOA04253	0.750	1.371	0.166/0.234	KC04	SOA04250	0.937	1.500	0.375	SB
SOA01835	0.750	1.373	0.374	SBF	SOA05278XX	0.937	1.624	0.250	SB1
SOA03179XX	0.750	1.375	0.250	TB	SOA05625	0.950	1.500	0.250	SB
SOA05030	0.750	1.383	0.374	SBF	SOA05217	0.968	1.625	0.234	TC
SOA04268	0.750	1.415	0.266	SBFR	SOA02409XX	0.984	1.378	0.250	SC12
SOA02475	0.750	1.499	0.250	SB	SOA02407XX	0.984	1.484	0.250	SC03
SOA02455	0.750	1.624	0.250	SB	SOA00826	0.984	1.484	0.297	SC04
SOA11711	0.750	1.625	0.312	TC	SOA00826XX	0.984	1.484	0.297	SC04
SOA06642XX	0.750	1.625	0.313	TA1	SOA04827XX	0.984	1.567	0.312	SC03
SOA06538	0.776	1.235	0.191	SBY	SOA01551XX	0.984	1.672	0.500	SC11
SOA03580	0.766	1.844	0.547	DC	SOA00122	1.000	1.250	0.125	VC
SOA05054	0.781	1.187	0.312	SC	SOA00813	1.000	1.250	0.125	VB
SOA00094	0.812	1.187	0.250	SC	SOA01867	1.000	1.250	0.125	VBF
SOA04252	0.812	1.567	0.250	TC	SOA06885	1.000	1.256	0.125	VB1
SOA05152	0.820	1.381	0.250	SBF	SOA03945	1.000	1.375	0.188	VB1
SOA04791	0.844	1.375	0.250	SC05	SOA00131	1.000	1.500	0.250	SC
SOA05216	0.859	1.625	0.234	TC	SOA07067	1.000	1.500	0.250	TB1
SOA06217	0.870	1.250	0.210	TC	SOA01088XX	1.000	1.500	0.256	TB
SOA11543	0.874	1.376	0.252	TC	SOA00135	1.000	1.500	0.375	SC
SOA11528	0.874	1.376	0.315	TB	SOA05029	1.000	1.500	0.500	TB
SOA01727XX	0.875	1.250	0.188	SB	SOA03505	1.000	1.562	0.187	VBF
SOA01811	0.875	1.250	0.188	SC	SOA03505XX	1.000	1.562	0.187	VBF
SOA03654XX	0.875	1.250	0.203	SBF	SOA06409	1.000	1.573	0.312	SB1
SOA04353	0.875	1.254	0.188	SBF	SOA03755	1.000	1.602	0.261	TB
SOA00102	0.875	1.375	0.250	SC	SOA11636	1.000	1.625	0.250	TC
SOA00103	0.875	1.375	0.250	TC	SOA00145	1.000	1.625	0.375	SC
SOA02481XX	0.875	1.375	0.250	SC05	SOA03877	1.000	1.625	0.375	SB
SOA06331XX	0.875	1.375	0.281	DC05	SOA02708XX	1.000	1.656	0.250	SC4
SOA05804XX	0.875	1.379	0.250	TB1	SOA02402	1.000	1.750	0.187	SB
SOA06563	0.875	1.380	0.250	TA1	SOA00146	1.000	1.750	0.250	SC
SOA02614	0.875	1.436	0.250	SB1	SOA01705	1.000	1.750	0.250	TB
SOA00109	0.875	1.500	0.250	SC	SOA00147	1.000	1.750	0.375	SC
SOA11772XX	0.875	1.500	0.262	TBY	SOA00886	1.000	1.750	0.375	TC
SOA01497XX	0.875	1.500	0.312	SBZ	SOA05376Z01	1.000	1.779	0.469	VB1
SOA04435	0.875	1.625	0.250	SB	SOA04521	1.000	1.781	0.469	VB1
SOA00116	0.875	1.625	0.375	TC	SOA11650	1.000	1.860	0.430	SC
SOA02691	0.875	2.000	0.437	SA1	SOA00152	1.000	2.000	0.250	SC
SOA11619	0.875	2.000	0.437	SB	SOA03209	1.000	2.000	0.250	TB
SOA03643	0.875	2.064	0.355	SC	SOA06036	1.000	2.000	0.250	SC
SOA06331	0.878	1.373	0.281/0.444	DC05	SOA00154	1.000	2.000	0.375	SC
SOA06331XX	0.878	1.373	0.281/0.444	DC05	SOA01144	1.000	2.000	0.375	TC

As the new tools adding continuously, please contact with our sales person for the newest tool list.

MFC OIL SEAL STANDARD SIZE LIST

【IMPERIAL】

ITEM NO.	ID	OD	H	TYPE	ITEM NO.	ID	OD	H	TYPE
SOA00156	1.000	2.000	0.500	SC	SOA04011	1.141	1.828	0.437	TC
SOA01706	1.000	2.000	0.500	TC	SOA05211	1.180	1.750	0.180	SB
SOA05409	1.000	2.000	0.515	DAY	SOA11524	1.181	1.691	0.374	TB
SOA01781	1.000	2.004	0.500	TC	SOA01084XX	1.187	1.714	0.500	TB1L
SOA03059	1.000	3.250	0.500	TB	SOA02611	1.187	1.718	0.500	TB5ZL
SOA04266	1.047	1.453	0.141/0.266	SP14	SOA01282	1.187	1.750	0.250	SC
SOA04602XX	1.047	1.469	0.203	SC	SOA04520	1.187	1.752	0.252	SB1
SOA03277	1.062	1.500	0.187	VB	SOA01861XX	1.187	2.437	0.468	SA
SOA02230XX	1.063	1.688	0.316	TBZ	SOA02232XX	1.188	1.688	0.316	TBZ
SOA04363	1.063	1.850	0.295	TC	SOA07050	1.188	1.983	0.250	TB
SOA06445XX	1.072	2.561	0.313	TB1	SOA03522XX	1.203	1.687	0.250	SBZ
SOA04790	1.078	1.625	0.375	SBF	SOA03145XX	1.219	1.499	0.188	VB
SOA05210	1.120	1.500	0.250	SC	SOA02693	1.219	1.979	0.375	KB1
SOA05358	1.120	1.750	0.370	SC	SOA02469	1.219	1.983	0.406	KB1
SOA11649	1.120	1.850	0.430	SB	SOA04787	1.234	1.738	0.250	SC
SOA11496	1.125	1.500	0.188	SBF	SOA00971	1.250	1.500	0.125	VC
SOA05437XX	1.125	1.500	0.219	SB1	SOA06886	1.250	1.506	0.125	VB1
SOA00166	1.125	1.500	0.250	SC	SOA17918	1.250	1.625	0.375	TC
SOA04014	1.125	1.500	0.250	SC	SOA06524XX	1.250	1.686	0.250	SA07
SOA02610	1.125	1.561	0.266	VBFB	SOA02550	1.250	1.687	0.187	VB
SOA00702	1.125	1.562	0.312	TC	SOA03615	1.250	1.687	0.218	VC
SOA00702XX	1.125	1.562	0.312	TC	SOA03329	1.250	1.687	0.250	SB
SOA00170	1.125	1.562	0.375	SC	SOA04168	1.250	1.687	0.250	TB
SOA00170XX	1.125	1.562	0.375	SC	SOA01084XX	1.250	1.714	0.500	TB1L
SOA06562	1.125	1.624	0.250	VB1	SOA04798	1.250	1.744	0.250	TCY
SOA00171	1.125	1.625	0.250	SC	SOA03225	1.250	1.750	0.250	SBR
SOA01769	1.125	1.625	0.250	TB	SOA06563	1.250	1.752	0.250	VB1
SOA03025	1.125	1.625	0.250	SB	SOA04326	1.250	1.875	0.398/0.437	TC7
SOA00750	1.125	1.625	0.370	SBF	SOA00217	1.250	1.875	0.437	TC
SOA00750XX	1.125	1.625	0.375	SBF	SOA05381	1.250	1.955	0.253	TB1
SOA01300	1.125	1.625	0.375	TC	SOA02674XX	1.250	1.979	0.250	TC
SOA02656	1.125	1.625	0.375	SB	SOA06880XX	1.250	1.979	0.250	VB1
SOA02656XX	1.125	1.625	0.375	SB	SOA03693XX	1.250	1.983	0.250	TC
SOA04805	1.125	1.750	0.312	SB	SOA06446XX	1.250	1.983	0.250	TB1
SOA03570	1.125	1.750	0.375	TC	SOA02692	1.250	1.983	0.252	TB1
SOA05157XX	1.125	1.874	0.250	TC4Y	SOA03155	1.250	2.000	0.250	SC
SOA06259	1.125	1.875	0.250	TB	SOA00221	1.250	2.000	0.375	SC
SOA00182	1.125	2.000	0.250	SC	SOA00225	1.250	2.000	0.500	SC
SOA00184	1.125	2.000	0.375	SC	SOA04013	1.250	2.000	0.687	TA1
SOA04797	1.125	2.250	0.359	SC	SOA03644	1.250	2.440	0.312	TC
SOA06559	1.125	2.047	0.250	VB1	SOA05076	1.250	2.441	0.313	TC
SOA05080	1.125	2.441	0.375	TC	SOA01326	1.250	2.500	0.375	TC
SOA06512	1.125	2.537	0.250	TC	SOA03345	1.290	2.000	0.312	TC
SOA11526	1.126	1.565	0.276	SC	SOA02229XX	1.290	2.000	0.316	TBZ
SOA05151	1.130	1.660	0.312	SBF	SOA04406	1.312	1.812	0.217	SB

As the new tools adding continuously, please contact with our sales person for the newest tool list.

MFC OIL SEAL STANDARD SIZE LIST

【IMPERIAL】

ITEM NO.	ID	OD	H	TYPE	ITEM NO.	ID	OD	H	TYPE
SOA04251	1.312	1.875	0.315	SB	SOA11569	1.496	2.057	0.275	TC
SOA00239	1.312	2.125	0.375	SC	SOA01513XX	1.496	2.284	0.315	TB102
SOA04671	1.313	2.603	0.250	VC	SOA01791	1.500	1.875	0.190	SC
SOA04049XX	1.327	2.065	0.406	SCW	SOA17783	1.500	1.937	0.250	SC
SOA05046	1.344	1.750	0.250	SB1	SOA06361XX	1.500	1.980	0.250	TB1
SOA06080XX	1.344	1.854	0.275	SC	SOA02098	1.500	1.983	0.188	VB1
SOA11804XX	1.350	2.250	0.500	SB	SOA02105	1.500	1.983	0.250	TB1
SOA02321	1.359	1.484	0.090	VB17	SOA02336XX	1.500	1.984	0.250	TBF
SOA05694	1.359	2.125	0.391	TB9E	SOA05357	1.500	1.989	0.250	KBY
SOA03072XX	1.359	2.203	0.359	TC9	SOA00985	1.500	2.000	0.218	SC
SOA04869	1.375	1.750	0.187	SBFY	SOA00284	1.500	2.000	0.250	SC
SOA06898XX	1.375	1.750	0.187	SBF	SOA00284XX	1.500	2.000	0.250	SC
SOA17816XX	1.375	1.750	0.187	SA1	SOA03519XX	1.500	2.000	0.250	KC
SOA02698	1.375	1.750	0.189	TC	SOA03553	1.500	2.000	0.250	VB
SOA03450XX	1.375	1.753	0.252	TC	SOA01770	1.500	2.000	0.312	TB
SOA03344	1.375	1.828	0.422	KDB02	SOA04627	1.500	2.000	0.334	TB
SOA02458	1.375	1.874	0.313	TB	SOA00287	1.500	2.062	0.250	SC
SOA01479XX	1.375	1.952	0.500	SA16	SOA01249XX	1.500	2.062	0.250	VC
SOA02719XX	1.375	1.953	0.479	TC7	SOA03809	1.500	2.062	0.252	SB
SOA05695	1.375	1.953	0.500	TBZ	SOA02255XX	1.500	2.249	0.380	SBZR
SOA00251	1.375	2.000	0.312	SB	SOA01944XX	1.500	2.249	0.380	SB1JR
SOA00255	1.375	2.000	0.375	SC	SOA05057	1.500	2.250	0.310	SB
SOA00256	1.375	2.000	0.500	SC	SOA00291	1.500	2.250	0.375	SC
SOA06936	1.375	2.125	0.313	TB	SOA05146	1.500	2.250	0.500	TA1
SOA02233XX	1.375	2.125	0.316	TBZ	SOA11706XX	1.500	2.328	0.500	VBUR
SOA02593	1.375	2.125	0.437	TA1	SOA03449XX	1.500	2.374	0.312	TC
SOA00264	1.375	2.250	0.375	SC	SOA03226	1.500	2.374	0.500	TBPL
SOA03454XX	1.375	2.374	0.375	TC	SOA05254	1.500	2.374	0.500	TB
SOA00268	1.375	2.375	0.500	SC	SOA02551	1.500	2.375	0.187	VB
SOA00269	1.375	2.500	0.500	SC	SOA03443	1.500	2.375	0.187	VB
SOA02451	1.375	2.500	0.500	TC7D	SOA00298	1.500	2.375	0.500	SC
SOA04886	1.375	2.500	0.500	TC7G	SOA00747	1.500	2.375	0.500	DC
SOA11533	1.378	1.829	0.252	TC	SOA01079	1.500	2.375	0.500	SA
SOA11538	1.378	2.159	0.433	TB	SOA02449	1.500	2.375	0.500	SCR
SOA11523	1.378	2.207	0.472	TB	SOA11498	1.500	2.375	0.500	TBR
SOA11521	1.378	2.372	0.500	SC	SOA02239	1.500	2.377	0.470	TBP02L
SOA11726XX	1.399	1.964	0.235	SBY	SOA03604	1.500	2.500	0.250	SB
SOA02050XX	1.399	2.292	0.460	TB401B	SOA00301	1.500	2.500	0.312	SC
SOA03603	1.430	2.500	0.500	SC	SOA11655	1.500	2.500	0.312	SB
SOA04786	1.437	2.008	0.250	SC05	SOA00305	1.500	2.500	0.500	SC
SOA05108	1.437	2.062	0.328	TCR	SOA05421	1.500	2.500	0.500	TC
SOA01779XX	1.440	2.061	0.500	SCVR	SOA02726XX	1.500	2.502	0.312	TB1
SOA03389XX	1.440	2.062	0.500	SB06	SOA04200	1.500	2.502	0.437	SB
SOA04911	1.469	2.328	0.391	VB1	SOA05032XX	1.500	2.586	0.420	EA501
SOA02320	1.484	1.609	0.125	VB17	SOA11529	1.504	2.500	0.437	SB1

As the new tools adding continuously, please contact with our sales person for the newest tool list.

MFC OIL SEAL STANDARD SIZE LIST

【IMPERIAL】

ITEM NO.	ID	OD	H	TYPE	ITEM NO.	ID	OD	H	TYPE
SOA02615	1.521	2.660	0.391	TBJR	SOA01523	1.718	2.561	0.500	TB1
SOA11535	1.551	2.502	0.500	TB	SOA01529	1.718	2.561	0.500	VB1
SOA02338XX	1.552	3.160	0.608	TBJ06	SOA04700	1.719	2.561	0.500	TB1
SOA00311XX	1.562	2.322	0.375	TC	SOA04861	1.720	2.561	0.500	TB1
SOA05860	1.562	2.374	0.312	TB1	SOA05028	1.720	2.561	0.500	VB03
SOA05009	1.562	2.375	0.500	SA1Y	SOA11805XX	1.734	2.406	0.375	SB
SOA06959	1.562	2.500	0.312	TB1	SOA01940XX	1.739	2.812	0.593	TBJ04
SOA02280XX	1.563	2.312	0.312	TC7R	SOA11527	1.740	2.813	0.583	TB
SOA03070XX	1.563	2.437	0.266	SBJR	SOA11495	1.750	2.125	0.195	SBF
SOA03794	1.563	2.500	0.500	SC	SOA04092	1.750	2.250	0.187	VB
SOA05412	1.565	1.937	0.250	TB1	SOA00340	1.750	2.250	0.312	TCN
SOA11539	1.575	2.057	0.138	TC	SOA02260XX	1.750	2.250	0.313	SB
SOA00755	1.593	1.937	0.250	TBF	SOA06364XX	1.750	2.325	0.312	VB1
SOA00755XX	1.593	1.937	0.250	TBF	SOA00346XX	1.750	2.375	0.375	TC
SOA11587	1.594	2.433	0.312	SCJY	SOA01771	1.750	2.378	0.312	TB
SOA11725XX	1.618	2.254	0.312	SB1	SOA05959	1.750	2.411	0.360	SB1
SOA02052XX	1.618	2.575	0.500	TB1	SOA03425	1.750	2.412	0.375	TB1R
SOA00763	1.625	2.000	0.250	SC	SOA04436	1.750	2.435	0.315	SB
SOA03390	1.625	2.000	0.266	SB	SOA03547	1.750	2.500	0.313	SB
SOA02699	1.625	2.000	1.189	TC	SOA00354	1.750	2.500	0.375	SB
SOA03605	1.625	2.250	0.375	SB	SOA00356	1.750	2.500	0.375	SC
SOA03721	1.625	2.250	0.375	TC	SOA02450	1.750	2.500	0.375	SCD
SOA04120	1.625	2.328	0.438	KB15	SOA00357	1.750	2.500	0.500	SC
SOA04162	1.625	2.375	0.250	VB	SOA05077	1.750	2.500	0.500	TB1
SOA05678	1.625	2.437	0.313	TC6	SOA01494	1.750	2.500	0.500	TC
SOA04903	1.625	2.500	0.250	TC	SOA05956	1.750	2.502	0.375	TB
SOA00877	1.625	2.625	0.375	TC	SOA11617	1.750	2.561	0.315	SC
SOA00332	1.625	2.750	0.500	SC	SOA00902	1.750	2.561	0.500	VB03
SOA05422	1.625	2.875	0.625	SCW	SOA02694	1.750	2.561	0.500	KB1
SOA02609	1.656	2.203	0.281	TCVE	SOA03514	1.750	2.563	0.500	KB1
SOA01647XX	1.656	2.623	0.385	TB07W	SOA03382	1.750	2.687	0.625	TC
SOA03775	1.675	2.375	0.350	TC	SOA02589	1.750	2.718	0.359	VB03
SOA06127	1.687	2.187	0.187	SC	SOA11707XX	1.750	2.718	0.359	VB03
SOA03559	1.687	2.187	0.787	SB	SOA00360	1.750	2.750	0.375	SC
SOA04910	1.687	2.328	0.391	SB1	SOA01105	1.750	2.750	0.375	TC
SOA02638XX	1.687	2.437	0.312	TB1	SOA00362	1.750	2.750	0.500	TC
SOA01772	1.687	2.500	0.312	TB	SOA05044	1.750	2.781	0.297	OEB5
SOA01106	1.687	2.500	0.375	TC	SOA05175	1.750	2.786	0.294	OEB5
SOA01930	1.687	2.500	0.375	DC	SOA11505	1.750	2.875	0.375	TB
SOA03455	1.687	2.560	0.375	TC28	SOA04046XX	1.750	2.875	0.468	TA
SOA02675XX	1.687	2.561	0.500	TC	SOA01897XX	1.750	2.875	0.484	SA1
SOA03694XX	1.687	2.563	0.500	TC	SOA01903XX	1.750	2.875	0.484	TA1
SOA06551	1.687	2.687	0.312	TB1	SOA00368	1.750	2.875	0.500	TC
SOA03546	1.688	2.502	0.313	SB	SOA05679	1.750	3.000	0.375	TC6
SOA02775XX	1.700	2.209	0.355	TBP01R	SOA00370	1.750	3.187	0.500	SC

As the new tools adding continuously, please contact with our sales person for the newest tool list.

MFC OIL SEAL STANDARD SIZE LIST

【IMPERIAL】

ITEM NO.	ID	OD	H	TYPE	ITEM NO.	ID	OD	H	TYPE
SOA05255	1.750	3.188	0.313	VB1	SOA05079	1.875	3.000	0.500	TB1
SOA03581	1.750	3.500	0.750	DC	SOA00398	1.875	3.125	0.500	TC
SOA11525	1.752	2.250	0.370	SC	SOA02430	1.875	3.160	0.562	TBJ12
SOA01943XX	1.763	2.409	0.375	TB1R	SOA01683XX	1.875	3.160	0.720	TBJ06
SOA01761	1.765	2.416	0.375	SC	SOA11708	1.875	3.181	0.313	SA1
SOA07049	1.766	2.416	0.375	TCVR	SOA11530	1.878	2.872	0.472	TB
SOA05613	1.772	3.500	0.742	DC01	SOA03419XX	1.906	2.891	0.328/0.422	AR05
SOA02607	1.781	2.412	0.375	TB1R	SOA01089XX	1.937	2.500	0.375	SB
SOA01908XX	1.781	2.686	0.375	SB	SOA06352	1.937	2.502	0.375	SB
SOA03230	1.797	2.578	0.281	TC	SOA01710XX	1.937	2.550	0.375	TC9
SOA04244	1.804	2.398	0.245	VBY	SOA01590	1.937	2.686	0.500	SBZ
SOA06876XX	1.810	1.937	0.120	VBF	SOA05078	1.937	2.750	0.375	TB1
SOA04795	1.812	2.563	0.375	SCG	SOA11520	1.937	2.994	0.500	TA
SOA01408	1.812	2.625	0.377	TC	SOA06266XX	1.938	2.437	0.250	SB1
SOA05195	1.812	3.000	0.500	TBJ05R	SOA06363	1.938	2.504	0.281	VB1
SOA11642XX	1.813	2.875	0.580	SC	SOA02773XX	1.938	2.627	0.374	TC
SOA04793	1.844	2.750	0.375	SC05	SOA01798XX	1.940	2.502	0.250	KBJ
SOA03457	1.844	2.787	0.359	TC	SOA01679XX	1.940	2.622	0.580	KDB03
SOA11597	1.850	2.750	0.500	DBY	SOA02258XX	1.940	2.762	0.500	TB105R
SOA11633	1.870	2.460	0.200	SC	SOA04761	1.970	3.061	0.500	VB03
SOA11639	1.870	2.500	0.312	SB	SOA11643XX	1.975	3.125	0.500	SC05
SOA05447	1.870	2.620	0.370	SC	SOA07069	2.000	2.275	0.312	TB1
SOA11541XX	1.870	2.750	0.370	SC	SOA02551	2.000	2.375	0.187	VB
SOA06279	1.870	2.810	0.310	SC	SOA04259	2.000	2.375	0.375	TC
SOA11519	1.874	2.781	0.571	TB	SOA11537	2.000	2.561	0.500	TB
SOA02772	1.875	2.502	0.250	VBU	SOA01511	2.000	2.562	0.220	KBJ
SOA03788	1.875	2.560	0.406	SB1	SOA01511XX	2.000	2.562	0.220	KBJ
SOA02776XX	1.875	2.561	0.612	TBJ13R	SOA11812XX	2.000	2.563	0.230	VB12
SOA03722	1.875	2.562	0.312	SB	SOA01512XX	2.000	2.623	0.260	KBJ4
SOA01514XX	1.875	2.561	0.528	TB06R	SOA03229	2.000	2.623	0.260	KB14
SOA04010	1.875	2.623	0.500	TA1	SOA01946XX	2.000	2.625	0.250	KB1
SOA01923XX	1.875	2.624	0.375	SBZR	SOA11810XX	2.000	2.625	0.250	VB
SOA04031XX	1.875	2.625	0.437	TCVR	SOA01817XX	2.000	2.625	0.375	TB1
SOA03191XX	1.875	2.625	0.500	TA1	SOA02244XX	2.000	2.625	0.650	KBJ04
SOA03756	1.875	2.633	0.347	VBF	SOA05214	2.000	2.686	0.250	VBU
SOA00389	1.875	2.750	0.375	SC	SOA01894XX	2.000	2.716	0.468	TA1
SOA01001	1.875	2.750	0.375	SB	SOA01508XX	2.000	2.746	0.375	SBZR
SOA00391	1.875	2.750	0.500	SC	SOA03219	2.000	2.750	0.250	TB
SOA04082XX	1.875	2.758	0.420	SBJR	SOA02274	2.000	2.750	0.312	TB
SOA00394	1.875	2.875	0.375	TC	SOA04902	2.000	2.750	0.312	TC
SOA01510XX	1.875	2.758	0.425	SBJR	SOA05359	2.000	2.750	0.370	SC
SOA00395	1.875	2.875	0.500	SC	SOA00417	2.000	2.750	0.375	SC
SOA03228	1.875	2.877	0.490	TB14	SOA01957	2.000	2.750	0.375	TC
SOA01921	1.875	3.000	0.375	TC	SOA04628	2.000	2.750	0.375	TB
SOA01495	1.875	3.000	0.500	TC	SOA00418	2.000	2.750	0.500	SC

As the new tools adding continuously, please contact with our sales person for the newest tool list.

MFC OIL SEAL STANDARD SIZE LIST

【IMPERIAL】

ITEM NO.	ID	OD	H	TYPE	ITEM NO.	ID	OD	H	TYPE
SOA06717XX	2.000	2.750	0.500	SC	SOA06135XX	2.250	3.370	0.375	VB1
SOA03131	2.000	3.000	0.375	TA	SOA00456	2.250	3.375	0.500	SC
SOA00429	2.000	3.000	0.500	SC	SOA06904	2.250	3.546	0.437	TC
SOA01017	2.000	3.000	0.500	TC	SOA04799	2.281	3.000	0.500	TCVR
SOA07068	2.000	3.000	0.500	TB1	SOA04789	2.281	3.130	0.375	SCH
SOA01627	2.000	3.061	0.250	VBU	SOA04904	2.281	3.375	0.937	DBY
SOA02583	2.000	3.061	0.500	VB03	SOA04449	2.297	3.000	0.235	VBV
SOA01346	2.000	3.375	0.500	SC	SOA00459	2.312	3.125	0.375	SC
SOA05034XX	2.000	3.623	0.250	VBU	SOA00463	2.312	3.355	3.120	TC
SOA00899	2.000	3.625	0.235	VB03	SOA01608	2.312	3.375	0.500	SC
SOA00433	2.062	2.937	0.343	TC	SOA07037XX	2.313	3.000	0.406	SB11
SOA00791XX	2.062	2.937	0.344	OEB02	SOA03220	2.330	2.997	0.312	KB1
SOA04012	2.063	3.000	0.375/0.594	TC9Z	SOA02653	2.375	2.750	0.312	SB
SOA04749XX	2.063	3.623	0.468	SA1	SOA11506	2.375	3.000	0.250	VB20
SOA03386	2.094	2.718	0.359	VB03	SOA01351	2.375	3.000	0.375	SC
SOA01711XX	2.125	2.750	0.406	TC9	SOA07045	2.375	3.002	0.437	SCL
SOA05006	2.125	2.755	0.312	TC	SOA04801	2.375	3.118	0.344	TAY
SOA03169	2.125	2.875	0.375	TC	SOA00469	2.375	3.125	0.375	SC
SOA00694	2.125	2.875	0.500	SB	SOA02401XX	2.375	3.125	0.375	TB1
SOA01222	2.125	2.875	0.500	SBF	SOA04800	2.375	3.125	0.375	SC
SOA05712	2.125	2.875	0.500	SA1	SOA05411	2.375	3.125	0.375	TCR
SOA17805XX	2.125	3.061	0.500	SA1	SOA00752XX	2.375	3.125	0.390	TBF
SOA05792XX	2.125	3.196	0.812	SA12Y	SOA01480XX	2.375	3.250	0.454	SB1
SOA04862	2.125	3.371	0.312	TB1	SOA02021XX	2.375	3.371	0.438	SA
SOA02096	2.125	3.371	0.313	VB1	SOA00475	2.375	3.375	0.500	TC
SOA05384	2.125	3.372	0.320	TB1	SOA01035	2.375	3.375	0.875	SA13
SOA02676XX	2.125	3.372	0.438	TC	SOA06716XX	2.375	3.471	0.294	OEB02
SOA03515	2.125	3.377	0.437	KB1	SOA01350	2.375	3.500	0.500	SC
SOA03695XX	2.125	3.377	0.438	TC	SOA04233	2.375	3.628	0.437	SA1
SOA02051XX	2.180	3.000	0.495	KB1	SOA05162XX	2.380	3.500	0.250	OEB5
SOA03027	2.250	2.875	0.375	SC	SOA06373	2.400	3.500	0.687	SA18
SOA02749	2.250	3.000	0.375	SB1	SOA11808XX	2.406	3.000	0.281	KB9
SOA00449	2.250	3.000	0.375	SC	SOA03576	2.406	3.125	0.375	TC7R
SOA01942XX	2.250	3.000	0.375	TB1	SOA05174	2.429	3.500	0.539	OEBY
SOA05260XX	2.250	3.000	0.375	TB1	SOA00479	2.437	3.250	0.375	SC
SOA03713	2.250	3.000	0.375	TC	SOA11531	2.441	3.939	0.669	SB1
SOA00451	2.250	3.000	0.500	TC	SOA01501	2.500	3.156	0.312	SB
SOA01942	2.250	3.000	0.500	TB	SOA00484	2.500	3.250	0.375	SC
SOA07068	2.250	3.000	0.500	TB1	SOA01945XX	2.500	3.251	0.375	TB1
SOA02480	2.250	3.000	0.500	TCR	SOA05685	2.500	3.282	0.312	TC
SOA03321	2.250	3.061	0.250	VBU	SOA02256XX	2.500	3.303	0.465	TBJ08B
SOA04553	2.250	3.250	0.500	SC	SOA11507	2.500	3.371	0.375	TB
SOA01896XX	2.250	3.251	0.500	TA1	SOA00487	2.500	3.375	0.500	SC
SOA03757	2.250	3.256	0.250	VBF	SOA06643XX	2.500	3.437	0.343	SB1
SOA02352XX	2.250	3.312	0.312	VBF	SOA00488	2.500	3.500	0.375	SC

As the new tools adding continuously, please contact with our sales person for the newest tool list.

MFC OIL SEAL STANDARD SIZE LIST

【IMPERIAL】

ITEM NO.	ID	OD	H	TYPE	ITEM NO.	ID	OD	H	TYPE
SOA00490	2.500	3.500	0.500	SC	SOA03227XX	2.875	3.875	0.515	TBJ14
SOA02770XX	2.500	3.500	0.500	TA1	SOA05123Z01	2.875	3.875	0.406/0.625	TAXY
SOA03758	2.500	3.500	0.500	VBF	SOA03972XX	2.875	3.876	0.188	VB24
SOA11534	2.500	3.500	0.500	SB1	SOA01411	2.875	4.125	0.375	TC
SOA11598XX	2.500	3.500	0.500	SBY	SOA05261XX	2.934	3.876	0.375	TC
SOA01561	2.500	3.500	0.687	SA18	SOA02585	2.937	3.937	0.438	VB03
SOA06388	2.500	3.625	0.500	TC	SOA06550	2.938	4.003	0.500	TB1
SOA00496	2.500	3.750	0.500	SC	SOA04408	3.000	3.625	0.250	VB
SOA02713	2.500	3.751	0.438	VB03	SOA00531	3.000	3.750	0.375	SC
SOA00497	2.562	3.375	0.375	SC	SOA01958	3.000	3.750	0.375	TC
SOA02771XX	2.563	3.440	0.344	SBZ	SOA02448	3.000	3.750	0.375	SCL
SOA02748XX	2.598	3.481	0.438	TA	SOA03595	3.000	3.751	0.375	SB1
SOA00500	2.625	3.375	0.375	SC	SOA04723	3.000	3.751	0.375	TC7Y
SOA00502	2.625	3.500	0.500	TC	SOA01286	3.000	4.000	0.375	SC
SOA03517XX	2.625	3.500	0.500	SB1	SOA03902	3.000	4.000	0.391	SB
SOA01395	2.625	3.500	0.500	TB	SOA00537	3.000	4.000	0.500	TC
SOA04047XX	2.625	3.500	0.500	TCY	SOA11522	3.000	4.002	0.472	SA1
SOA00867	2.625	3.625	0.500	SC	SOA04199	3.000	4.249	0.468	SA1
SOA03606	2.625	3.625	0.500	SB	SOA00541	3.062	4.125	0.500	SC
SOA01646XX	2.625	4.564	0.718	TBJ04	SOA02500XX	3.109	3.748	0.437	SCVL
SOA05155	2.630	3.750	0.375	TC	SOA01545XX	3.110	3.764	0.435	SCL
SOA04629	2.687	3.625	0.563	TB02	SOA01320XX	3.125	3.750	0.250	KB
SOA05834	2.687	3.750	0.500	TC	SOA05671	3.125	3.750	0.430	TCL
SOA04823	2.720	3.751	0.438	VB03	SOA11654XX	3.125	3.938	0.500	SA
SOA00508	2.750	3.500	0.375	SC	SOA00548	3.125	4.000	0.500	SC
SOA00941	2.750	3.500	0.500	SC	SOA07035	3.125	4.250	0.500	SA1
SOA01802	2.750	3.625	0.563	TB02	SOA02308	3.155	3.350	0.398	SP15
SOA00513	2.750	3.750	0.500	SC	SOA04657XX	3.250	4.250	0.375	TB
SOA06218	2.750	3.750	0.500	SBF	SOA00556	3.250	4.250	0.500	TC
SOA04901	2.750	3.750	0.625	TC	SOA11799XX	3.250	4.450	0.492	SBJ03L
SOA02584	2.750	3.751	0.438	VB03	SOA00805	3.250	4.500	0.500	SC
SOA05815	2.750	3.875	0.375	TC	SOA11578XX	3.250	4.500	0.625	TA1
SOA00517	2.750	4.000	0.500	SC	SOA17806XX	3.312	5.125	0.500	SA1
SOA11518	2.752	3.876	0.500	SA1	SOA03582	3.313	4.375	0.500	TC
SOA04447	2.831	3.939	0.275	VBY	SOA00560	3.375	4.375	0.500	SC
SOA03261	2.843	3.939	0.495	TA1B	SOA00807	3.375	4.375	0.500	TC
SOA01939XX	2.844	3.939	0.495	TA1A	SOA02507	3.375	4.500	0.500	SB
SOA02606	2.859	3.939	0.500	TB	SOA02608	3.375	4.506	0.563	TCVR
SOA00524	2.875	3.625	0.375	SC	SOA06168	3.375	4.999	0.500	SA1
SOA01056	2.875	3.625	0.375	TC	SOA00564	3.500	4.000	0.252	VB
SOA01034XX	2.875	3.750	0.375	SA1	SOA03569	3.500	4.375	0.250	VBU
SOA03878	2.875	3.750	0.500	SB	SOA01868XX	3.500	4.500	0.437	SA
SOA04174	2.875	3.875	0.500	SC	SOA00569	3.500	4.500	0.500	TC
SOA01644XX	2.875	3.875	0.515	TBJ03	SOA00970XX	3.500	4.750	0.250	VBU
SOA03227	2.875	3.875	0.515	TBJ14	SOA01274	3.500	4.750	0.562	TC

As the new tools adding continuously, please contact with our sales person for the newest tool list.

MFC OIL SEAL STANDARD SIZE LIST

【IMPERIAL】

ITEM NO.	ID	OD	H	TYPE	ITEM NO.	ID	OD	H	TYPE
SOA01362	3.500	5.000	0.500	SC	SOA02654	4.500	5.500	0.500	SB
SOA03879	3.500	5.000	0.500	SB	SOA04411	4.500	5.750	0.375	OSA1
SOA01226	3.500	6.146	1.546	TA01	SOA11536	4.500	6.124	0.551	TA
SOA01321	3.563	4.500	0.467	TA	SOA00624	4.500	6.125	0.562	SC
SOA00745	3.625	4.499	0.468	TA1	SOA03724	4.500	6.250	0.625	SB
SOA00580	3.625	4.625	0.500	TC	SOA04119	4.625	5.500	0.500	TB
SOA06265XX	3.625	5.251	0.375	TB1	SOA03723	4.625	6.000	0.500	SB
SOA03648	3.730	4.500	0.375	SCL	SOA00699	4.687	5.984	0.875	TC06
SOA04198	3.750	4.499	0.468	SA1	SOA00799	4.750	5.750	0.500	SC
SOA00586	3.750	4.750	0.500	TC	SOA03464	4.750	6.000	0.562	SB
SOA02616	3.750	5.062	0.500	OSB	SOA00978	4.875	5.750	0.437	SC
SOA00588	3.750	5.250	0.625	SC	SOA01370	4.875	5.875	0.500	SC
SOA00589	3.812	4.875	0.500	SC	SOA00635	5.000	6.000	0.500	SC
SOA00590	3.812	4.875	0.500	TC	SOA06283	5.000	6.000	0.500	SB1
SOA04405	3.850	5.251	0.438	VAY	SOA01890XX	5.000	6.003	0.500	TB1
SOA00591	3.875	4.875	0.500	SC	SOA01532XX	5.000	6.250	0.500	TA
SOA11657	3.875	4.990	0.464	SB	SOA03341	5.000	6.250	0.562	SB
SOA02586	3.875	5.251	0.438	VB03	SOA03607	5.125	6.125	0.500	SB
SOA03301	4.000	5.000	0.312	SA1	SOA00637	5.125	6.125	0.500	SC
SOA11630	4.000	5.000	0.312	VB03	SOA00639	5.250	6.250	0.500	SC
SOA01887XX	4.000	5.000	0.437	DA201	SOA03880	5.250	6.250	0.500	SB
SOA00593	4.000	5.000	0.500	SB	SOA05410	5.250	6.250	0.500	SCW
SOA00595	4.000	5.000	0.500	TC	SOA02482	5.250	6.250	0.500/0.594	TC24L
SOA00596	4.000	5.000	0.500	TB	SOA03793	5.250	6.250	0.563	SB
SOA01735Z01	4.000	5.125	0.562	SBF	SOA03577	5.313	6.250	0.438	TC7L
SOA11817	4.000	5.126	0.315	SA1	SOA03112	5.500	6.250	0.438	SC
SOA05782	4.000	5.370	0.430	SB	SOA06873	5.500	6.250	0.438	TCN
SOA05849	4.000	5.375	0.500	TBF	SOA00803	5.500	6.250	0.500	SC
SOA00603	4.000	5.500	0.500	SC	SOA00646	5.750	6.750	0.500	SC
SOA06585	4.125	5.000	0.438	SA1	SOA03779	5.875	6.875	0.625	SB
SOA01195	4.125	5.125	0.500	SC	SOA00650	6.000	7.000	0.500	SB
SOA03343	4.166	5.501	0.600	SA1C	SOA00651	6.000	7.000	0.500	SC
SOA06059XX	4.187	4.999	0.468	TA1	SOA06027	6.000	7.000	0.500	TB6Y
SOA02508	4.250	5.000	0.500	SB	SOA00652	6.125	7.125	0.500	SC
SOA00608	4.250	5.250	0.500	SC	SOA03566	6.250	7.188	0.625	TBF
SOA01004	4.250	5.250	0.500	TC	SOA00654	6.250	7.250	0.500	SC
SOA03339	4.250	5.250	0.500	SB	SOA00655	6.250	7.250	0.500	TC
SOA03340	4.250	5.500	0.562	SB	SOA00753XX	6.250	7.500	0.625	TB01
SOA06552XX	4.250	5.786	0.500	SC	SOA06953	6.250	7.750	0.750	DBY
SOA03946	4.375	5.375	0.500	DC	SOA11574XX	7.000	8.000	0.125	VBY
SOA06902	4.375	5.375	0.560	OSA1					
SOA02000	4.375	5.751	0.438	SA					
SOA00614	4.375	6.000	0.500	TC					
SOA01269	4.500	5.250	0.437	SB					
SOA03026	4.500	5.375	0.437	SB					

As the new tools adding continuously, please contact with our sales person for the newest tool list.

MFC OIL SEAL STANDARD SIZE LIST

【METRIC】

ITEM NO.	ID	OD	H	TYPE	ITEM NO.	ID	OD	H	TYPE
SOM17829XX	4.00	15.00	4.00	VC	SOM05451	10.00	16.00	4.00	TC
SOM04802	4.50	16.00	7.00	TC	SOM08178	10.00	17.00	4.00	VC
SOM05453	4.50	16.00	8.00	TC	SOM00074	10.00	18.00	6.00	SC
SOM05452	4.80	17.00	7.00	TC	SOM00074XX	10.00	18.00	6.00	SC
SOM07611XX	5.00	10.00	2.00	VBF	SOM00078	10.00	19.00	7.00	SC
SOM03651	5.00	16.00	6.00	SC	SOM00079	10.00	19.00	7.00	TC
SOM09008	5.50	16.00	8.00	KC6	SOM00080	10.00	20.00	5.00	TC
SOM05455	5.50	26.20	6.00	TC	SOM02403	10.00	22.00	6.00	TC
SOM00020XX	6.00	15.00	4.00	SC	SOM00085	10.00	22.00	7.00	SC
SOM02603	6.00	16.00	5.00	SC	SOM10678	10.00	25.00	3.8 / 4.6	KCY
SOM02603XX	6.00	16.00	5.00	SC	SOM00090	10.00	25.00	7.00	TC
SOM05377	6.00	16.00	5.00	TC	SOM00093	10.00	26.00	7.00	TC
SOM00023	6.00	16.00	7.00	SC	SOM05882XX	10.00	28.00	13.40	TC
SOM17250	6.00	17.00	6.00	TC	SOM00095	10.00	30.00	7.00	SC
SOM17652	6.00	19.00	7.00	SC	SOM04803	10.00	40.00	10.00	TC
SOM17566	6.00	22.00	2.00	VB	SOM10606	10.50	39.50	8.00	OVCY
SOM04801	6.00	22.00	7.00	TC	SOM00097	11.00	17.00	4.00	SC
SOM05450	6.50	14.50	7.00	TC	SOM02687	11.00	17.00	4.00	TC
SOM02847	7.00	16.00	7.00	TC	SOM05947	11.00	17.00	4.00	TCV
SOM17558	8.00	12.00	3.00	VBF	SOM00101	11.00	22.00	7.00	TC
SOM03428	8.00	14.00	4.00	SC	SOM07436XX	11.00	37.00	4.0 / 8.5	TC42
SOM09914	8.00	14.00	4.00	SBF	SOM09238	11.00	37.00	4.0 / 8.5	TC42
SOM00040	8.00	15.00	5.00	SC	SOM03835	11.60	24.00	10.00	TC
SOM17202	8.00	15.00	5.50	TBF	SOM08963	11.90	21.00	4.00	SC
SOM00042	8.00	16.00	6.00	SC	SOM03896	12.00	16.00	3.00	VC
SOM00042XX	8.00	16.00	6.00	SC	SOM08383	12.00	16.00	3.00	VBF
SOM09053	8.00	16.00	6.50	SC	SOM08179	12.00	17.00	4.00	VC
SOM00044	8.00	16.00	7.00	SC	SOM05263	12.00	18.00	3.00	VBF
SOM00045	8.00	16.00	7.00	TC	SOM15860	12.00	18.00	4.00	SC
SOM07884	8.00	18.00	4.00	SC	SOM10800	12.00	18.00	5.00	KC
SOM00046	8.00	18.00	5.00	SC	SOM17565	12.00	19.00	3.00	VB
SOM00046XX	8.00	18.00	5.00	SC	SOM05877	12.00	19.00	4.5 / 7.5	TC07
SOM10300	8.00	18.00	5.00	TC	SOM00109	12.00	19.00	5.00	SC
SOM02829	8.00	18.00	6.00	TC	SOM02010	12.00	19.00	5.00	TC
SOM05007	8.00	19.00	7.00	SC	SOM00112	12.00	20.00	5.00	SC
SOM01952	8.00	22.00	4.00	SC	SOM00114	12.00	20.00	5.00	TC
SOM10071	8.00	22.00	4.00	TB	SOM08672XX	12.00	20.00	5.0 / 7.0	TC7Y
SOM10773	8.00	22.00	4.00	TC	SOM00120	12.00	22.00	5.00	SC
SOM07164	8.00	22.00	6.00	TC	SOM00121	12.00	22.00	5.00	TC
SOM00050	8.00	22.00	7.00	SC	SOM10756	12.00	22.00	5.00	TB
SOM07598	8.00	24.00	7.00	TC	SOM03907	12.00	22.00	6.00	TC
SOM04929XX	9.00	18.00	7.00	TC	SOM15380	12.00	22.00	6.5 / 8.0	TB7Y
SOM10301	9.00	20.00	5.00	TC	SOM00122	12.00	22.00	7.00	TC
SOM09663	9.00	26.00	7.00	TC	SOM00123	12.00	22.00	7.00	SC
SOM00067	10.00	16.00	4.00	SC	SOM08975	12.00	22.00	7.00	KC
SOM00068	10.00	16.00	4.00	VB	SOM16940	12.00	22.00	7.00	TB
					SOM03374XX	12.00	22.00	8.00	SC

As the new tools adding continuously, please contact with our sales person for the newest tool list.

MFC OIL SEAL STANDARD SIZE LIST

【METRIC】

ITEM NO.	ID	OD	H	TYPE	ITEM NO.	ID	OD	H	TYPE
SOM03914XX	12.00	24.00	4.50	SC	SOM00204	15.00	24.00	7.00	TC
SOM05149	12.00	24.00	4.5 / 5.5	TC7	SOM00205	15.00	24.00	7.00	TBF
SOM17252	12.00	24.00	6.50	TC	SOM03050	15.00	24.50	5.00	TB1
SOM00128	12.00	24.00	7.00	TC	SOM10658	15.00	25.00	4.00	TC
SOM02377	12.00	24.00	7.00	SC	SOM04280	15.00	25.00	5.00	TC
SOM10531	12.00	24.00	7.00	SCD	SOM00210	15.00	25.00	7.00	TC
SOM03923	12.00	25.00	5.00	TC	SOM08959	15.00	25.50	7.00	TC
SOM00131	12.00	25.00	7.00	TC	SOM00213	15.00	26.00	6.00	TB
SOM00136	12.00	26.00	8.00	SC	SOM00214	15.00	26.00	6.00	TC
SOM00139	12.00	28.00	7.00	SC	SOM08990	15.00	26.00	6.00	TBF
SOM00140	12.00	28.00	7.00	TC	SOM00216	15.00	26.00	7.00	SC
SOM03935	12.00	32.00	5.50	TC	SOM00218	15.00	26.00	7.00	TC
SOM00148	12.00	32.00	7.00	SC	SOM07116	15.00	26.00	8.00	TC
SOM16665	12.00	35.00	6.40	TC	SOM00219	15.00	27.00	7.00	TC
SOM02281XX	12.30	50.80	45.20	SP01	SOM00224	15.00	28.00	7.00	SC
SOM02281Z01	12.30	50.80	45.20	SP01	SOM16767	15.00	28.00	7.00	TC4
SOM10687	12.50	21.00	7.00	TC3	SOM16224	15.00	29.60	6.00	TB
SOM05517	13.00	19.00	5.00	VBZ	SOM16624	15.00	29.60	6.00	TB
SOM02221	13.00	22.00	4.00	SC	SOM00226	15.00	30.00	4.50	SC
SOM05537	13.00	22.00	4.00	SC	SOM10755	15.00	30.00	5.50	TB
SOM00157	13.00	22.00	5.00	SC	SOM00229	15.00	30.00	7.00	TC
SOM04030	13.00	22.00	5.00	TBF	SOM00229XX	15.00	30.00	7.00	TC
SOM17592	13.00	23.00	4.00	TC	SOM00230	15.00	30.00	7.00	TB
SOM08593	13.50	27.00	8.5/10.0	TC22	SOM00231	15.00	30.00	8.00	SC
SOM04047	13.70	24.00	5.00	SC	SOM00234	15.00	30.00	10.00	TC
SOM17549	14.00	20.00	3.00	VBF	SOM00235	15.00	32.00	7.00	SC
SOM05454	14.00	20.00	4.00	TB	SOM00236	15.00	32.00	7.00	TC
SOM00170	14.00	22.00	4.00	SC	SOM07816	15.00	32.00	7.50	TCAY
SOM02700	14.00	22.00	4.5/5.0	TC	SOM10908	15.00	32.00	9.00	TCY
SOM05878	14.00	23.00	7.0/10.0	TC307	SOM15322	15.00	35.00	5.30	SC
SOM00177	14.00	24.00	7.00	SC	SOM15195	15.00	35.00	6.00	TC
SOM00178	14.00	24.00	7.00	TC	SOM00240	15.00	35.00	7.00	TC
SOM00182	14.00	25.00	7.00	TC	SOM07767	15.00	35.00	7.00	TB
SOM05328	14.00	25.00	18.00	TC43	SOM08994	15.00	35.00	7.00	TBF
SOM00186	14.00	28.00	7.00	TC	SOM00244	15.00	35.00	10.00	SC
SOM04208	14.00	30.00	7.00	TC	SOM00245	15.00	35.00	10.00	TC
SOM03385	14.50	25.50	5.00	TC7	SOM05553	15.00	36.00	7.00	SC
SOM07454XX	14.50	35.00	7.00	TC	SOM09005	15.00	40.00	2.5 / 3.0	VCY
SOM04464	14.70	29.50	5.00	TBZ	SOM09001	15.0/15.8	26.00	6.0 / 7.0	TBY
SOM02380	15.00	21.00	3.00	VC	SOM05593	15.40	28.50	9.50	TC
SOM17599	15.00	21.00	3.00	KC	SOM16002XX	15.50	35.00	8.00	SCY
SOM03394	15.00	23.00	4.00	VC	SOM07117	15.80	28.50	9.50	TC
SOM00199	15.00	24.00	5.00	SC	SOM07138	16.00	21.00	4.50	TC
SOM04274	15.00	24.00	5.00	TC	SOM04960	16.00	24.00	4.00	SB
SOM05040XX	15.00	24.00	5.00	TC	SOM17129	16.00	24.00	4.00	VCY
SOM00200	15.00	24.00	7.00	DB	SOM10946	16.00	24.00	5.00	SC
SOM00203	15.00	24.00	7.00	SC	SOM05634	16.00	24.00	6.00	KC7V

As the new tools adding continuously, please contact with our sales person for the newest tool list.

MFC OIL SEAL STANDARD SIZE LIST

【METRIC】

ITEM NO.	ID	OD	H	TYPE	ITEM NO.	ID	OD	H	TYPE
SOM00263	16.00	24.00	7.00	SC	SOM09630	17.00	33.00	7.00	TB
SOM17253	16.00	25.00	7.00	TC	SOM00319	17.00	35.00	7.00	SC
SOM05617	16.00	26.00	5.00	TC	SOM00321	17.00	35.00	7.00	TC
SOM00264	16.00	26.00	7.00	SC	SOM00323	17.00	35.00	8.00	TC
SOM03429	16.00	26.00	7.00	SC	SOM03474	17.00	35.00	10.00	TC
SOM16269	16.00	26.00	8.00	TC	SOM16625	17.00	39.50	5.00	SC
SOM07748XX	16.00	26.00	8.0 / 19.0	SP30	SOM10777	17.00	39.90	5.20	TB
SOM00266	16.00	28.00	7.00	SC	SOM07620	17.00	40.00	5.00	SC
SOM00267	16.00	28.00	7.00	TC	SOM08060	17.00	40.00	5.00	TC
SOM10519	16.00	28.00	7.00	SCD	SOM00330	17.00	40.00	7.00	SC
SOM08435XX	16.00	28.00	7.0 / 7.5	TC7	SOM00333	17.00	40.00	8.00	TC
SOM00270	16.00	30.00	6.00	TC	SOM15648	17.00	40.00	8.50	TC
SOM00271	16.00	30.00	7.00	SC	SOM16973	17.00	40.00	8.50	SC
SOM00272	16.00	30.00	7.00	TC	SOM02130	17.00	47.00	7.00	SC
SOM08974	16.00	30.00	8.00	KC	SOM05456	17.46	28.50	6.30	TC
SOM12089	16.00	30.00	10.00	TC	SOM07672	17.50	32.50	3.5 / 8.5	TC42
SOM00278	16.00	32.00	7.00	SC	SOM03413	18.00	24.00	3.00	VBF
SOM04304	16.00	32.00	7.00	TC	SOM10943	18.00	24.00	3.00	VBY
SOM00285	16.00	40.00	8.00	SC	SOM17600	18.00	24.00	3.00	KC
SOM02084	16.00	40.00	10.00	TC	SOM11483	18.00	24.00	4.00	VBF
SOM07612XX	16.00	44.00	4.20	TC57	SOM04867XX	18.00	24.00	4.0 / 4.5	TC7
SOM16953	16.30	24.00	7.00	SC	SOM11967	18.00	26.00	6.00	TC
SOM10675	16.80	30.00	9.00	TC	SOM09916	18.00	27.00	5.50	KCY
SOM07591XX	17.00	26.00	5.00	TC	SOM00349	18.00	28.00	7.00	TC
SOM05390	17.00	27.00	7.00	TC	SOM01946	18.00	28.00	7.00	SC
SOM08057	17.00	28.00	4.50	TC	SOM02190	18.00	30.00	6.00	TC
SOM08966	17.00	28.00	5.50	TCL	SOM09917	18.00	30.00	6.5 / 8.0	TCVY
SOM08686	17.00	28.00	5.60	SC	SOM00354	18.00	30.00	7.00	TC
SOM05660	17.00	28.00	6.00	TB	SOM05533	18.00	31.00	7.00	TC
SOM00299	17.00	28.00	7.00	SC	SOM00357	18.00	32.00	7.00	SC
SOM00299XX	17.00	28.00	7.00	SC	SOM00358	18.00	32.00	7.00	TC
SOM00301	17.00	28.00	7.00	TC	SOM05535	18.00	32.00	7.00	DC
SOM07139	17.00	28.00	7.0 / 13.0	SB07R	SOM00360	18.00	32.00	8.00	TC
SOM03047	17.00	28.00	8.00	DB	SOM04672	18.00	32.00	10.0 / 15.0	DC05
SOM00303	17.00	28.50	6.00	SC	SOM00362	18.00	35.00	7.00	TC
SOM05534	17.00	28.50	7.00	DC	SOM09937	18.00	40.00	7.00	SCVI
SOM08964	17.00	29.00	5.30	SC	SOM08996	18.00	40.00	8.00	TC
SOM07118	17.00	29.00	8.00	TC	SOM00373	18.90	30.00	5.00	SC
SOM07119	17.00	29.00	13.00	TC	SOM02604	18.90	30.00	5.00	TC
SOM07642	17.00	30.00	5.00	TC	SOM10263XX	19.00	27.00	4.50	VCY
SOM00308	17.00	30.00	6.00	TC	SOM16982	19.00	29.10	6.40	SC
SOM02578	17.00	30.00	6.00	SC	SOM16705	19.00	30.00	4.50	VBF
SOM00310	17.00	30.00	7.00	SC	SOM04975	19.00	30.00	7.00	TC
SOM00311	17.00	30.00	7.00	TC	SOM05532	19.00	31.50	6.50	SB
SOM07590	17.00	30.00	7.00	DC	SOM00379	19.00	32.00	7.00	SC
SOM17489	17.00	30.00	10.00	SC	SOM00382	19.00	35.00	7.00	TC
SOM00313	17.00	32.00	7.00	SC	SOM00384	19.00	35.00	10.00	SC

As the new tools adding continuously, please contact with our sales person for the newest tool list.

MFC OIL SEAL STANDARD SIZE LIST

【METRIC】

ITEM NO.	ID	OD	H	TYPE	ITEM NO.	ID	OD	H	TYPE
SOM05325	19.00	35.50	2.5 / 10.0	TC42	SOM00423	20.00	35.00	6.00	SC
SOM02045	19.00	37.00	10.00	SB	SOM00424	20.00	35.00	6.00	TC
SOM00386	19.00	40.00	10.00	SC	SOM00426	20.00	35.00	7.00	SC
SOM03524	19.00	47.00	12.50	TB	SOM00427	20.00	35.00	7.00	TC
SOM04598	19.00	47.00	12.50	TC	SOM17454XX	20.00	35.00	7.00	KCY
SOM17444	19.05	30.00	3.00	KC	SOM05272	20.00	35.00	7.0 / 10.0	SC17R
SOM17791	19.50	28.60	6.00	TC	SOM00431	20.00	35.00	8.00	TC
SOM12445	19.50	35.10	7.00	TC	SOM00432	20.00	35.00	10.00	SC
SOM08970	19.80	30.00	5.00	TC	SOM00433	20.00	35.00	10.00	TC
SOM09629	20.00	26.00	4.00	VB	SOM08973	20.00	37.00	8.00	TCY
SOM02284	20.00	28.00	4.00	VB	SOM08615	20.00	38.00	7.00	SC
SOM17672	20.00	28.00	4.00	TC	SOM08967	20.00	38.00	7.00	TCYL
SOM02327	20.00	28.00	6.00	TC	SOM17215	20.00	38.10	10.00	SC
SOM00397	20.00	28.00	7.00	SC	SOM00441	20.00	40.00	6.00	TC
SOM03484	20.00	28.00	7.00	TC	SOM00443	20.00	40.00	7.00	TC
SOM03395	20.00	30.00	4.00	VC	SOM00445	20.00	40.00	8.00	TC
SOM00399	20.00	30.00	4.50	SC	SOM00446	20.00	40.00	10.00	SC
SOM00402	20.00	30.00	5.00	SC	SOM00449	20.00	40.00	10.00	TC
SOM00403	20.00	30.00	5.00	TC	SOM05618	20.00	42.00	6.00	TC
SOM09627	20.00	30.00	5.00	TB	SOM00451	20.00	42.00	7.00	SC
SOM00404	20.00	30.00	6.00	SC	SOM00452	20.00	42.00	7.00	TC
SOM03527	20.00	30.00	6.00	TB	SOM00454	20.00	42.00	10.00	SC
SOM05067XX	20.00	30.00	6.00	TBF	SOM03206	20.00	42.00	10.00	TC
SOM07497	20.00	30.00	6.00	SCN	SOM15323	20.00	47.00	5.30	SC
SOM16138	20.00	30.00	6.50	TCN	SOM00459	20.00	47.00	7.00	SC
SOM05949	20.00	30.00	4.0 / 7.0	DB05	SOM00460	20.00	47.00	7.00	TC
SOM00407	20.00	30.00	7.00	SC	SOM00461	20.00	47.00	8.00	TC
SOM00408	20.00	30.00	7.00	TB	SOM00462	20.00	47.00	8.50	SC
SOM00409	20.00	30.00	7.00	TC	SOM00464	20.00	47.00	10.00	SC
SOM04691	20.00	30.00	7.00	TCR	SOM00464XX	20.00	47.00	10.00	SC
SOM07450	20.00	30.00	7.00	DB05	SOM00465	20.00	47.00	10.00	TC
SOM09026	20.00	30.00	7.00	SBZ	SOM00465XX	20.00	47.00	10.00	TC
SOM08767	20.00	30.00	7.0 / 8.0	TC7	SOM16959	20.00	47.10	10.00	SC
SOM10747	20.00	30.00	7.0 / 8.0	TC7V	SOM02943XX	20.00	47.20	14.00	VB02
SOM04322	20.00	31.00	7.00	TBZ	SOM00472	20.00	52.00	8.00	TC
SOM08960	20.00	31.00	7.00	TC	SOM00474	20.00	52.00	10.00	TC
SOM00413	20.00	32.00	5.00	SC	SOM07095	20.00	52.00	10.00	SB
SOM00431	20.00	32.00	5.00	SC	SOM17057	20.00	62.00	8.00	TC
SOM04843	20.00	32.00	5.00	VC	SOM17221	20.60	38.10	7.00	TB
SOM08971	20.00	32.00	6.00	TC	SOM05351	21.00	35.00	6.00	SC
SOM00414	20.00	32.00	7.00	SC	SOM08021	21.00	35.00	6.00	TC
SOM00415	20.00	32.00	7.00	TC	SOM00481	21.00	40.00	7.00	TC
SOM00416	20.00	32.00	8.00	TC	SOM00481XX	21.00	47.00	7.00	TC
SOM04671	20.00	32.00	10.0 / 15.0	DC05	SOM11102XX	21.20	27.90	4.0 / 4.8	KB02
SOM00418	20.00	34.00	7.00	SC	SOM04787	21.50	40.00	7.50	SBIR
SOM04673	20.00	34.00	10.0 / 15.0	DC05	SOM09918	21.90	40.00	8.00	TCVLY
SOM05724XX	20.00	35.00	5.30	SC05	SOM17203	22.00	30.00	5.00	KC

As the new tools adding continuously, please contact with our sales person for the newest tool list.

MFC OIL SEAL STANDARD SIZE LIST

【METRIC】

ITEM NO.	ID	OD	H	TYPE	ITEM NO.	ID	OD	H	TYPE
SOM02044	22.00	32.00	3.00	KB	SOM05661XX	24.00	40.00	7.00	SC09
SOM03675	22.00	32.00	6.00	TC	SOM00546	24.00	40.00	8.00	TC
SOM00488	22.00	32.00	7.00	SC	SOM08168	24.00	40.00	10.00	SC
SOM00489	22.00	32.00	7.00	TC	SOM15673	24.00	42.00	7.00	SC
SOM05610	22.00	32.00	7.00	DC	SOM00552	24.00	47.00	7.00	TC
SOM08587XX	22.00	32.00	7.00	SC29	SOM02694	24.00	47.00	10.00	TC
SOM00490	22.00	32.00	7.50	TC	SOM11223	24.00	49.00	12.00	TC
SOM05536	22.00	33.00	7.00	TB	SOM05663XX	24.50	35.00	7.50	SC10
SOM08977	22.00	33.00	7.00	TC	SOM08520XX	24.50	41.00	3.0 / 7.5	SCY
SOM07868XX	22.00	34.50	8.50	TC42	SOM16981	24.60	39.90	8.00	TB
SOM04504	22.00	35.00	6.00	TC	SOM02428	25.00	32.00	4.00	VC
SOM10859	22.00	35.00	6.70	SC	SOM07214	25.00	32.00	4.00	VB
SOM12404	22.00	35.00	6.70	TC	SOM00567	25.00	35.00	6.00	TC
SOM17794	22.00	35.00	6.50	SC	SOM17039	25.00	35.00	6.00	TCR
SOM00494	22.00	35.00	7.00	SC	SOM17039XX	25.00	35.00	6.00	TCR
SOM00495	22.00	35.00	7.00	TC	SOM00570	25.00	35.00	7.00	SC
SOM05457	22.00	35.00	7.00	TB	SOM00571	25.00	35.00	7.00	TB
SOM07501	22.00	36.00	6.00	SCN	SOM00572	25.00	35.00	7.00	TC
SOM00498	22.00	36.00	7.00	SC	SOM05946	25.00	35.00	7.00	SBF
SOM04674	22.00	36.00	10.0 / 15.0	DC05	SOM10470	25.00	35.00	7.00	SBY
SOM07121	22.00	38.00	10.00	TC	SOM08586XX	25.00	35.00	8.00	SC29
SOM00505	22.00	40.00	7.00	SC	SOM09736	25.00	35.00	9.0 / 10.0	TC4Y
SOM00506	22.00	40.00	7.00	TC	SOM15507	25.00	35.00	10.00	TC
SOM00508	22.00	40.00	8.00	TC	SOM00578	25.00	36.00	7.00	SC
SOM00511	22.00	40.00	10.00	TC	SOM11066	25.00	37.00	5.00	SC
SOM10347	22.00	41.20	7.00	TC	SOM00582	25.00	37.00	7.00	SC
SOM00512	22.00	42.00	7.00	TC	SOM00583	25.00	37.00	7.00	TC
SOM11226	22.00	42.00	12.00	TC	SOM00587	25.00	38.00	7.00	TC
SOM11821XX	22.00	45.00	7.00	TC24LY	SOM02254	25.00	38.00	7.00	TB
SOM07137	22.00	45.00	8.00	TC	SOM00589	25.00	38.00	8.00	TC
SOM15397	22.00	45.00	8.00	TCVLY	SOM17872	25.00	40.00	3.00	VB
SOM15397XX	22.00	45.00	8.00	TCVLY	SOM00590	25.00	40.00	5.00	SC
SOM05538	22.00	47.00	9.00	TA1	SOM00593	25.00	40.00	7.00	SC
SOM17251	22.00	52.00	7.00	TC	SOM00594	25.00	40.00	7.00	TB
SOM11242	22.20	28.70	3.20	VC	SOM00595	25.00	40.00	7.00	TC
SOM05595XX	23.00	30.00	5.50	SC10	SOM00597	25.00	40.00	8.00	SC
SOM00526	23.00	35.00	7.00	TC	SOM00598	25.00	40.00	8.00	TC
SOM05226	23.00	35.00	8.50	TB	SOM08972	25.00	40.00	9.00	TC
SOM07120	23.00	36.00	7.00	TC	SOM00599	25.00	40.00	10.00	SC
SOM07669	23.00	40.00	10.00	TC	SOM00600	25.00	40.00	10.00	TC
SOM03213	23.00	47.00	10.00	TC	SOM03531	25.00	40.00	10.00	SB
SOM08519XX	23.50	30.00	4.50	SP14	SOM00602	25.00	41.20	6.00	TC
SOM08961	24.00	31.00	3.50	KC	SOM02253	25.00	41.20	7.00	TB
SOM09081	24.00	32.00	7.00	VC1	SOM00604	25.00	42.00	6.00	SC
SOM09628	24.00	36.00	6.00	TC	SOM00606	25.00	42.00	7.00	SC
SOM02690	24.00	37.00	7.00	TC	SOM00607	25.00	42.00	7.00	TC
SOM03121	24.00	40.00	7.00	TC	SOM11771XX	25.00	42.00	7.00	TC24R

As the new tools adding continuously, please contact with our sales person for the newest tool list.

MFC OIL SEAL STANDARD SIZE LIST

【METRIC】

ITEM NO.	ID	OD	H	TYPE	ITEM NO.	ID	OD	H	TYPE
SOM00609	25.00	42.00	8.00	TC	SOM00666	26.00	37.00	7.00	TC
SOM15234	25.00	42.00	8.00	SCVR	SOM00667	26.00	38.00	5.00	TC
SOM15234XX	25.00	42.00	8.00	SCVR	SOM05095	26.00	38.00	8.00	TC
SOM00611	25.00	42.00	10.00	SC	SOM08855	26.00	40.00	6.50	TC
SOM00612	25.00	42.00	10.00	TC	SOM04638	26.00	40.00	7.00	TB
SOM05219	25.00	43.00	10.00	SC	SOM07942	26.00	42.00	7.00	TC
SOM00614	25.00	44.00	7.00	TC	SOM08604	26.00	42.00	8.00	TCR
SOM00614XX	25.00	44.00	7.00	TC	SOM08604XX	26.00	42.00	8.00	TCR
SOM00616	25.00	45.00	7.00	TC	SOM15508	26.00	42.00	8.00	TC
SOM07122	25.00	45.00	8.00	TC	SOM07146	26.00	43.00	7.00	TC
SOM00618	25.00	45.00	10.00	SC	SOM02058	26.00	43.00	10.00	TC
SOM00619	25.00	45.00	10.00	TC	SOM05948	26.00	45.00	10.00	SBF
SOM09923	25.00	46.00	7.00	SC	SOM07180	26.00	47.00	7.00	TC
SOM15324	25.00	47.00	5.30	SC	SOM09688	27.00	37.00	7.00	TC
SOM00623	25.00	47.00	7.00	TB	SOM09735	27.00	37.00	7.5 / 9.0	TC7
SOM00624	25.00	47.00	7.00	TC	SOM08979	27.00	39.00	10.50	TC4Y
SOM08991	25.00	47.00	7.00	DC06Y	SOM09009	27.00	39.00	10.50	TB4
SOM10775	25.00	47.00	7.00	DC06V	SOM02168	27.00	40.00	7.00	TC
SOM16773	25.00	47.00	7.00	SB1	SOM07430	27.00	40.00	8.00	TC
SOM00626	25.00	47.00	8.00	TB	SOM07716	27.00	41.00	10.00	SC
SOM00628	25.00	47.00	10.00	SC	SOM05549	27.00	41.50	7.00	TB
SOM00630	25.00	47.00	10.00	TC	SOM08968	27.00	42.00	7.00	TC
SOM00633	25.00	48.00	8.00	TC	SOM07123	27.00	42.00	9.00	TC
SOM17783XX	25.00	49.50	11.00	TC302	SOM03122	27.00	42.00	10.00	TC
SOM03611	25.00	50.00	10.00	TC	SOM05054	27.00	43.00	9.00	TC
SOM00641	25.00	52.00	7.00	SC	SOM15509	27.00	47.00	10.00	TC
SOM00642	25.00	52.00	7.00	TB	SOM15500	27.00	49.00	10.00	SCY
SOM00643	25.00	52.00	7.00	TC	SOM07165	27.00	53.00	7.00	TC
SOM17878	25.00	52.00	8.00	DC	SOM10688	27.0/55.5	70.00	9.0 / 18.5	SPY
SOM00645	25.00	52.00	8.00	TC	SOM12465	27.95	56.00	10.00	TC
SOM00648	25.00	52.00	10.00	SC	SOM05217	28.00	35.00	4.00	VB
SOM00649	25.00	52.00	10.00	TC	SOM17686XX	28.00	37.00	6.00	VBZ
SOM00649XX	25.00	52.00	10.00	TC	SOM09870	28.00	38.00	6.00	TC
SOM03253	25.00	52.00	10.00	DC03	SOM00696	28.00	38.00	7.00	TC
SOM05941	25.00	52.00	11.0 / 12.0	DC03	SOM10722	28.00	38.00	7.00	TCR
SOM17415XX	25.00	62.00	6.00	DC14Y	SOM10722XX	28.00	38.00	7.00	TCR
SOM00654	25.00	62.00	7.00	SC	SOM05323	28.00	38.00	10.0 / 15.0	TC26L
SOM00655	25.00	62.00	7.00	TC	SOM00699	28.00	40.00	7.00	SC
SOM00656	25.00	62.00	8.00	SC	SOM00700	28.00	40.00	7.00	TC
SOM00659	25.00	62.00	10.00	SC	SOM05945	28.00	40.00	7.00	TC7
SOM02186	25.00	62.00	10.00	TC	SOM00701	28.00	40.00	8.00	TC
SOM02313XX	25.00	62.20	15.00	VB02	SOM07499	28.00	40.00	8.00	DC
SOM09237	25.00	82.50	8.50	TB05	SOM11050XX	28.00	40.00	8.00	TCVRY
SOM10833XX	25.00	52.0/60.0	12.0 / 18.0	SP31	SOM11949	28.00	40.00	8.00	TBF
SOM17035	25.40	47.00	8.00	KC	SOM08732	28.00	41.50	9.40	TB
SOM10822	26.00	32.00	4.0 / 5.0	KB02	SOM17455XX	28.00	42.00	6.0 / 9.0	KC09
SOM00665	26.00	37.00	7.00	SC	SOM00704	28.00	42.00	7.00	TC

As the new tools adding continuously, please contact with our sales person for the newest tool list.

MFC OIL SEAL STANDARD SIZE LIST

【METRIC】

ITEM NO.	ID	OD	H	TYPE	ITEM NO.	ID	OD	H	TYPE
SOM09939	28.00	42.00	7.00	TCVR	SOM12035	30.00	40.00	7.00	TB1
SOM09939XX	28.00	42.00	7.00	TCVR	SOM17212	30.00	40.00	7.00	TB
SOM00705	28.00	42.00	8.00	TC	SOM00740	30.00	40.00	8.00	TC
SOM00712	28.00	45.00	8.00	TC	SOM08978	30.00	40.50	10.50	TC4
SOM00714	28.00	47.00	7.00	SC	SOM10122	30.00	40.50	10.50	TB4
SOM00715	28.00	47.00	7.00	TC	SOM17494XX	30.00	40.60	10.00	TBL
SOM07124	28.00	47.00	8.00	TC	SOM00742	30.00	42.00	4.50	SC
SOM10259	28.00	47.00	8.00	DC	SOM10693	30.00	42.00	4.50	TC
SOM00717	28.00	47.00	10.00	TC	SOM00744	30.00	42.00	6.00	TC
SOM16944	28.00	47.00	10.00	SA1	SOM11766XX	30.00	42.00	6.00	TCVR
SOM05322	28.00	47.00	10.00	TC4R	SOM17337	30.00	42.00	6.00	TCNY
SOM17207	28.00	47.00	10.00	SA	SOM00746	30.00	42.00	7.00	SC
SOM05520	28.00	49.80	16.00	SB17R	SOM00747	30.00	42.00	7.00	TB
SOM00722	28.00	52.00	7.00	TC	SOM00748	30.00	42.00	7.00	TC
SOM07125	28.00	52.00	10.00	TC	SOM07096	30.00	42.00	7.00	TC7R
SOM07126	28.00	56.00	10.00	TC	SOM09015	30.00	42.00	7.00	TCR
SOM05519	28.00	70.00	10.00	TC48R	SOM09015XX	30.00	42.00	7.00	TCR
SOM07144	28.00	70.00	10.00	TC	SOM00750	30.00	42.00	8.00	TC
SOM11281	28.50	35.00	4.00	VB1	SOM01995	30.00	42.00	10.00	TC
SOM02794	28.50	39.50	9.50	TC	SOM09004	30.00	42.00	10.50	TC4
SOM17210	28.50	50.70	10.00	SB	SOM07949	30.00	42.00	7.0 / 8.0	TC7L
SOM03148	28.60	43.00	6.50	TBF	SOM11553	30.00	42.05	8.00	SC
SOM07503	28.60	43.00	6.50	TBF	SOM09694	30.00	43.00	8.00	TC
SOM15497	29.00	41.00	6.00	TCVR	SOM17043	30.00	43.00	8.00	TCVR
SOM15692	29.00	45.00	7.00	SC	SOM17043XX	30.00	43.00	8.00	TCVR
SOM11464	29.00	45.00	8.00	TCL	SOM11003XX	30.00	44.00	5.30	VCY
SOM11464XX	29.00	45.00	8.00	TCL	SOM04452	30.00	44.00	7.00	TC
SOM07145	29.00	46.00	10.00	TC	SOM04492	30.00	44.00	7.00	TCR
SOM02696	29.00	50.00	10.00	TC	SOM04492XX	30.00	44.00	7.00	TCR
SOM05540	29.00	50.00	10.00	TA1	SOM03451	30.00	44.00	10.00	SC
SOM05707	29.00	50.00	10.00	SA	SOM00756	30.00	45.00	7.00	TC
SOM05860	29.00	52.00	10.50	TC	SOM00758	30.00	45.00	8.00	TC
SOM15661XX	29.00	77.00	30.5 / 45.0	TCLY	SOM05066XX	30.00	45.00	8.00	TC3
SOM07920	29.50	52.00	10.00	TC	SOM05467	30.00	45.00	8.00	TB
SOM09097	29.50	52.00	10.50	TCY	SOM07174	30.00	45.00	8.00	SBR
SOM07173	29.80	47.00	9.90	TC	SOM00761	30.00	45.00	10.00	TC
SOM07173XX	29.80	47.00	9.90	TC	SOM00762	30.00	45.00	11.00	TC
SOM09052	29.85	47.00	11.30	TCVRY	SOM16761	30.00	46.00	7.00	TCR
SOM08180	30.00	36.00	5.00	VC	SOM10776	30.00	46.00	8.00	TC
SOM17835	30.00	37.00	7.00	KC	SOM00769	30.00	47.00	6.00	TC
SOM15159	30.00	37.40	3.60	VBF	SOM08613	30.00	47.00	6.00	SC
SOM07049	30.00	38.00	4.00	VC	SOM00771	30.00	47.00	7.00	SC
SOM16704	30.00	40.00	2.00	VC	SOM00772	30.00	47.00	7.00	TC
SOM03689	30.00	40.00	4.00	VC	SOM00772XX	30.00	47.00	7.00	TC
SOM00736	30.00	40.00	7.00	SC	SOM07874	30.00	47.00	8.00	DC
SOM00737	30.00	40.00	7.00	TC	SOM10310	30.00	47.00	8.00	TB
SOM11768XX	30.00	40.00	7.00	TCVR	SOM15267	30.00	47.00	8.00	TCV

As the new tools adding continuously, please contact with our sales person for the newest tool list.

MFC OIL SEAL STANDARD SIZE LIST

【METRIC】

ITEM NO.	ID	OD	H	TYPE	ITEM NO.	ID	OD	H	TYPE
SOM00777	30.00	47.00	10.00	SC	SOM16985	31.70	50.80	11.00	TB
SOM05692	30.00	47.00	10.00	TC	SOM17684	32.00	39.00	6.00	KC20Z
SOM09869	30.00	47.00	10.00	SB	SOM00847	32.00	42.00	7.00	SC
SOM00780	30.00	48.00	8.00	TC	SOM05324	32.00	42.00	10.0 / 15.0	TC26L
SOM00782	30.00	50.00	7.00	SC	SOM09403	32.00	44.00	8.0 / 9.5	TC7
SOM00784	30.00	50.00	8.00	TC	SOM11024	32.00	44.00	9.00	SB1
SOM00787	30.00	50.00	10.00	SC	SOM17793	32.00	44.50	9.00	SC03
SOM00788	30.00	50.00	10.00	TC	SOM00855	32.00	45.00	7.00	SC
SOM00789	30.00	50.00	11.00	TC	SOM00856	32.00	45.00	7.00	TC
SOM15158XX	30.00	50.00	11.00	TC	SOM07175	32.00	45.00	8.00	SBR
SOM11542	30.00	50.75	11.00	SC	SOM00860	32.00	45.00	10.00	TC
SOM00794	30.00	52.00	7.00	SC	SOM07176	32.00	45.00	10.00	SBR
SOM00795	30.00	52.00	7.00	TB	SOM04489	32.00	46.00	6.00	TCR
SOM00796	30.00	52.00	7.00	TC	SOM04489XX	32.00	46.00	6.00	TCR
SOM02240	30.00	52.00	7.00	TBL	SOM05458	32.00	46.00	8.00	TCL
SOM10889	30.00	52.00	7.00	TCR	SOM05327	32.00	47.00	6.00	TCR
SOM10889XX	30.00	52.00	7.00	TCR	SOM05327XX	32.00	47.00	6.00	TCR
SOM00799	30.00	52.00	8.00	TC	SOM00864	32.00	47.00	7.00	SC
SOM05313	30.00	52.00	8.00	SB	SOM00865	32.00	47.00	7.00	TC
SOM05539	30.00	52.00	9.00	TA1	SOM07349	32.00	47.00	8.0 / 14.0	TC7
SOM00801	30.00	52.00	10.00	SC	SOM05178	32.00	47.00	8.00	TC
SOM00803	30.00	52.00	10.00	TC	SOM05314	32.00	47.00	8.00	TCR
SOM07657	30.00	52.00	10.00	TCW	SOM05314XX	32.00	47.00	8.00	TCR
SOM00808	30.00	55.00	7.00	SC	SOM00868	32.00	47.00	10.00	TC
SOM00809	30.00	55.00	7.00	TC	SOM05310	32.00	47.00	10.00	TCVR
SOM00811	30.00	55.00	10.00	TC	SOM05310XX	32.00	47.00	10.00	TCVR
SOM00814	30.00	55.00	12.00	TC	SOM15231	32.00	47.00	10.00	TCV
SOM08058	30.00	62.00	5.00	TC	SOM15231XX	32.00	47.00	10.00	TCV
SOM16251XX	30.00	62.00	6.00	DC14Y	SOM17453	32.00	47.00	10.00	TC24V
SOM00817	30.00	62.00	7.00	SB	SOM04478	32.00	48.00	7.00	TCR
SOM00818	30.00	62.00	7.00	SC	SOM00872	32.00	48.00	8.00	TC
SOM00820	30.00	62.00	7.00	TC	SOM00872XX	32.00	48.00	8.00	TC
SOM00822	30.00	62.00	8.00	TC	SOM17760XX	32.00	50.00	7.00	TCVR
SOM00824	30.00	62.00	10.00	SC	SOM00876	32.00	50.00	10.00	TC
SOM00825	30.00	62.00	10.00	TC	SOM00876XX	32.00	50.00	10.00	TC
SOM11550	30.00	62.00	10.00	SB1	SOM12056	32.00	50.00	7.0 / 8.5	TC7
SOM16986	30.00	72.00	6.50	TC	SOM17879	32.00	52.00	7.00	DC
SOM00833	30.00	72.00	10.00	TC	SOM00878	32.00	52.00	7.00	SC
SOM17116	30.00	45.0 / 62.0	41.00	TCLY	SOM00879	32.00	52.00	7.00	TC
SOM10834	30.00	62.0 / 70.0	13.0 / 19.0	SP31	SOM07177	32.00	52.00	7.00	SBR
SOM05879	30.00	63.0 / 52.0	27.00	DC16	SOM00881	32.00	52.00	8.00	TC
SOM05817	30.50	55.00	10.00	TC7V	SOM00882	32.00	52.00	10.00	SC
SOM17817	31.00	41.00	10.00	TB	SOM03490	32.00	52.00	11.00	TC
SOM09428	31.00	41.00	10.00	TC	SOM05063	32.00	52.00	11.00	TCL
SOM08962	31.00	43.00	10.30	DC4	SOM05063XX	32.00	52.00	11.00	TCL
SOM16958	31.00	47.00	7.00	TC	SOM00886	32.00	54.00	10.00	TC
SOM02698	31.00	52.00	7.00	TC	SOM11134	32.00	55.00	10.00	SC

As the new tools adding continuously, please contact with our sales person for the newest tool list.

MFC OIL SEAL STANDARD SIZE LIST

【METRIC】

ITEM NO.	ID	OD	H	TYPE	ITEM NO.	ID	OD	H	TYPE
SOM02935	32.00	56.00	10.00	TC	SOM10623	35.00	48.00	7.00	TCVR
SOM05545	32.00	57.20	10.00	TC	SOM10886	35.00	48.00	7.00	TCR
SOM05518	32.00	62.00	8.00	DC12	SOM10886XX	35.00	48.00	7.00	TCR
SOM00894	32.00	62.00	10.00	TC	SOM11231	35.00	48.00	7.00	TC
SOM05096	33.00	44.00	8.00	TBF	SOM00940	35.00	48.00	8.00	TC
SOM07178	33.00	48.00	8.00	TC	SOM11235	35.00	48.00	10.00	TCVR
SOM08061	33.00	50.00	6.00	TC	SOM17119	35.00	48.00	13.0 / 15.0	TBJY
SOM09709	33.00	50.00	10.00	TC	SOM05516	35.00	48.00	15.00	TC46
SOM16977	33.00	51.90	12.00	TB	SOM02602	35.00	49.00	6.00	TCR
SOM03594	33.00	52.00	6.00	SC	SOM02602XX	35.00	49.00	6.00	TCR
SOM00904	33.00	52.00	10.00	SC	SOM04114	35.00	49.00	6.00	TC
SOM07301	33.00	54.00	6.50	TC	SOM05632	35.00	49.00	6.00	TCR
SOM09249	33.00	57.00	9.00	VB1	SOM05632XX	35.00	49.00	6.00	TCR
SOM17213	33.30	69.40	7.90	SB	SOM16799	35.00	49.00	12.50	TB
SOM04577XX	33.70	52.40	10.30	SCR	SOM05459	35.00	49.20	12.50	TCL
SOM08965	34.00	39.00	3.00	VC	SOM15842	35.00	50.00	6.00	VC
SOM08969	34.00	41.00	4.00	KC	SOM00606	35.00	50.00	7.00	SC
SOM15213	34.00	45.00	7.00	SB	SOM00943	35.00	50.00	7.00	SC
SOM05280	34.00	48.00	7.00	TCR	SOM00944	35.00	50.00	7.00	TC
SOM05280XX	34.00	48.00	7.00	TCR	SOM08819	35.00	50.00	7.00	TCR
SOM03274	34.00	50.00	7.00	TC	SOM08819XX	35.00	50.00	7.00	TCR
SOM07956	34.00	50.00	9.50	TB20A	SOM00945	35.00	50.00	8.00	SC
SOM00914	34.00	52.00	10.00	SC	SOM00945XX	35.00	50.00	8.00	SC
SOM05317	34.00	52.00	10.00	TC	SOM00946	35.00	50.00	8.00	TC
SOM15633	34.00	55.00	10.00	TC	SOM07179	35.00	50.00	8.00	TCR
SOM16988	34.00	62.10	10.00	SC	SOM08432	35.00	50.00	8.00	SCR
SOM16274XX	34.50	58.00	10.00	DCY	SOM08432XX	35.00	50.00	8.00	SCR
SOM11048XX	34.80	54.00	10.0 / 15.0	TB9XY	SOM11767XX	35.00	50.00	8.00	SC
SOM16962	34.90	52.30	9.50	SA1	SOM16095	35.00	50.00	8.00	TCV
SOM11280	35.00	42.00	3.70	VB1	SOM16095XX	35.00	50.00	8.00	TCV
SOM16971	35.00	44.50	7.00	SB1	SOM17249XX	35.00	50.00	8.00	TC
SOM03696	35.00	45.00	4.00	VC	SOM00948	35.00	50.00	10.00	SC
SOM00921	35.00	45.00	6.00	SC	SOM00949	35.00	50.00	10.00	TC
SOM00922	35.00	45.00	7.00	SB	SOM03492	35.00	50.00	11.00	TC
SOM00923	35.00	45.00	7.00	SC	SOM04597XX	35.00	50.00	12.00	TC
SOM00924	35.00	45.00	7.00	TC	SOM03021	35.00	50.00	13.00	TB01L
SOM00929	35.00	47.00	7.00	SC	SOM00952	35.00	52.00	7.00	SC
SOM00928	35.00	47.00	7.00	SB	SOM00953	35.00	52.00	7.00	TC
SOM00931	35.00	47.00	7.00	TC	SOM00955	35.00	52.00	8.00	TC
SOM03334	35.00	47.00	7.00	SCR	SOM00957	35.00	52.00	10.00	SC
SOM03334XX	35.00	47.00	7.00	SCR	SOM00958	35.00	52.00	10.00	TC
SOM05855	35.00	47.00	7.00	TCR	SOM11361	35.00	52.00	12.00	TC
SOM15246XX	35.00	47.00	7.00	SCVRY	SOM17790	35.00	53.90	8.00	TB
SOM00933	35.00	47.00	8.00	TC	SOM05382	35.00	54.00	10.00	TC
SOM00937	35.00	47.00	10.00	TC	SOM16322	35.00	54.00	11.00	TC
SOM17240	35.00	48.00	4.00	VC	SOM00962	35.00	55.00	8.00	TC
SOM04499XX	35.00	48.00	7.00	SC	SOM00964	35.00	55.00	10.00	SC

As the new tools adding continuously, please contact with our sales person for the newest tool list.

MFC OIL SEAL STANDARD SIZE LIST

【METRIC】

ITEM NO.	ID	OD	H	TYPE	ITEM NO.	ID	OD	H	TYPE
SOM00964XX	35.00	55.00	10.00	SC	SOM15499	36.00	48.00	7.00	TCR
SOM00965	35.00	55.00	10.00	TC	SOM04115	36.00	50.00	7.00	TC
SOM00967	35.00	55.00	11.00	TC	SOM09056	36.00	50.00	7.00	TC24R
SOM00967XX	35.00	55.00	11.00	TC	SOM09472	36.00	50.00	7.00	TC24RY
SOM08614	35.00	55.00	11.00	TC3	SOM10621	36.00	50.00	7.00	SCR
SOM05336	35.00	55.00	12.00	TB	SOM10621XX	36.00	50.00	7.00	SCR
SOM05697	35.00	55.00	12.00	TC	SOM02408	36.00	50.00	8.00	TC
SOM09433	35.00	55.00	12.00	TB1	SOM09181XX	36.00	50.00	8.00	SCR
SOM16146	35.00	55.00	12.00	SB1	SOM09056XX	36.00	50.70	7.00	TC24R
SOM03023	35.00	55.00	15.00	TBJ01	SOM08549	36.00	52.00	10.00	TCL
SOM04935XX	35.00	56.00	8.0 / 11.5	TC9L	SOM17101	36.00	52.60	12.50	SCVRY
SOM00969	35.00	56.00	10.00	SC	SOM16978	36.00	54.00	7.00	TB
SOM00970	35.00	56.00	10.00	TC	SOM04836	36.00	54.00	7.50	TC
SOM05546	35.00	58.00	8.00	TB	SOM02059	36.00	54.00	11.00	TC
SOM00973	35.00	58.00	10.00	SC	SOM04679XX	36.00	60.00	9.50	TC
SOM05404	35.00	58.00	10.00	TCW	SOM03504	36.00	62.00	7.00	TC
SOM00974	35.00	60.00	10.00	SC	SOM05515	37.00	49.00	8.00	TC7
SOM03489	35.00	60.00	10.00	TC	SOM16976	37.00	50.00	10.00	TC
SOM00975	35.00	60.00	12.00	TC	SOM03162	37.00	52.00	8.00	SC
SOM00978	35.00	62.00	7.00	SC	SOM16692	37.00	54.00	5.0 / 8.5	TC07
SOM00980	35.00	62.00	7.00	TC	SOM08322	37.00	58.00	13.00	TC
SOM03850	35.00	62.00	8.00	TC	SOM08813	38.00	43.00	3.00	VBF
SOM16956	35.00	62.00	9.50	SB1	SOM04173XX	38.00	47.00	10.00	SB
SOM05316	35.00	62.00	9.0 / 12.0	TC9	SOM16990	38.00	47.60	6.50	SB1
SOM04943XX	35.00	62.00	9.0 / 12.5	TC901R	SOM08617	38.00	48.00	4.00	VC
SOM05318	35.00	62.00	10.0 / 16.5	TC9	SOM01028	38.00	50.00	7.00	SC
SOM00983	35.00	62.00	10.00	SC	SOM01029	38.00	50.00	7.00	TC
SOM00985	35.00	62.00	10.00	TC	SOM04956	38.00	50.00	7.00	SCD
SOM16009	35.00	62.00	10.00	SA	SOM10083	38.00	50.00	7.00	SCD
SOM00987	35.00	62.00	12.00	SC	SOM01028	38.00	50.00	7.00	SC
SOM00988	35.00	62.00	12.00	TC	SOM15529	38.00	50.00	7.00	SBF
SOM00992	35.00	65.00	10.00	TC	SOM01031	38.00	50.00	8.00	TC
SOM16935	35.00	63.50	12.70	SA1	SOM04488	38.00	50.00	8.00	TCR
SOM00995	35.00	68.00	10.00	SC	SOM04488XX	38.00	50.00	8.00	TCR
SOM05321	35.00	72.00	7.5 / 9.5	TC41	SOM05041XX	38.00	50.00	9.00	TCL
SOM10475	35.00	72.00	7.5 / 9.5	TC41	SOM01035	38.00	52.00	7.00	SC
SOM00998	35.00	72.00	8.00	TC	SOM01037	38.00	52.00	7.00	TC
SOM01000	35.00	72.00	10.00	TC	SOM01039	38.00	52.00	8.00	TC
SOM01981	35.00	72.00	10.00	SC	SOM01044	38.00	52.00	10.00	TC
SOM16961	35.00	72.00	10.00	SA1	SOM11753	38.00	54.00	7.00	TCR
SOM01003	35.00	72.00	12.00	TC	SOM04934XX	38.00	54.00	8.0 / 11.5	TC9L
SOM08123XX	35.00	72.0 / 80.0	12.0 / 19.5	SP31	SOM01047	38.00	54.00	10.00	SC
SOM04940XX	35.00	76.00	9.0 / 12.5	TC901L	SOM01050	38.00	55.00	7.00	SC
SOM04942XX	35.00	76.00	9.0 / 12.5	TC901R	SOM07287	38.00	55.00	9.00	TC3
SOM09496	35.00	80.00	7.00	SB1	SOM01055	35.00	56.00	10.00	TC
SOM16987	35.00	82.90	10.00	TC	SOM00969	35.00	56.00	10.00	TC
SOM01010	36.00	47.00	7.00	SC	SOM01064	38.00	58.00	11.00	TB

As the new tools adding continuously, please contact with our sales person for the newest tool list.

MFC OIL SEAL STANDARD SIZE LIST

【METRIC】

ITEM NO.	ID	OD	H	TYPE	ITEM NO.	ID	OD	H	TYPE
SOM01065	38.00	58.00	11.00	TC	SOM05309	40.00	52.00	9.00	TCVB
SOM05064XX	38.00	58.00	11.00	TB3	SOM17555XX	40.00	52.00	6.5 / 7.5	TC40
SOM11678	38.00	58.00	11.0 / 17.0	TC9	SOM04576XX	40.00	54.00	5.00	VBF
SOM05073	38.00	58.00	18.00	SA18	SOM03399XX	40.00	54.00	7.00	TB
SOM08998	38.00	58.50	7.00	TC	SOM08731	40.00	54.00	7.00	VBF
SOM17774XX	38.00	58.90	8.3 / 9.3	TC7R	SOM01097	40.00	55.00	7.00	SC
SOM05315	38.00	60.00	8.00	TC	SOM01098	40.00	55.00	7.00	TC
SOM07041	38.00	62.00	8.00	TC	SOM16871	40.00	55.00	7.00	TC
SOM01071	38.00	62.00	10.00	SC	SOM01099	40.00	55.00	8.00	SC
SOM05544	38.00	63.50	12.70	SA1	SOM01100	40.00	55.00	8.00	TC
SOM05093	38.00	65.00	9.00	TBF3	SOM01100XX	40.00	55.00	8.00	TC
SOM08062	38.00	65.00	10.00	TC	SOM05514	40.00	55.00	8.00	TCV
SOM02450	38.00	72.00	10.00	SC	SOM11051XX	40.00	55.00	8.00	TC04
SOM02034	38.00	74.00	11.00	TB	SOM01101	40.00	55.00	10.00	SC
SOM02039	38.00	74.00	11.00	TBR	SOM03018	40.00	55.00	10.00	TC04W
SOM05071	38.00	74.00	11.00	TB1	SOM05147	40.00	55.00	10.00	TC
SOM05071XX	38.00	74.00	11.00	TB1	SOM11244	40.00	55.50	4.00	TC
SOM17504	38.00	74.00	11.0 / 18.0	TBPI	SOM01103	40.00	56.00	7.00	SC
SOM09246	38.00	80.40	7.5 / 16.5	TBFY	SOM01105	40.00	56.00	7.00	TC
SOM05065XX	38.50	58.00	11.00	TC3	SOM02038	40.00	56.00	7.00	SBR
SOM15210XX	38.80	52.00	7.60	TC9	SOM02229	40.00	56.00	7.00	TBL
SOM04633XX	39.00	50.40	7.00	TB1	SOM01106	40.00	56.00	8.00	SC
SOM02062	39.50	60.00	10.00	TC	SOM04421	40.00	56.00	8.00	TC
SOM05719	39.50	60.00	10.00	SB18	SOM16968	40.00	56.00	9.00	TB
SOM16941	39.70	61.20	12.70	SA1	SOM04938XX	40.00	56.00	8.0 / 11.5	TC9L
SOM08181	40.00	47.00	5.00	VC	SOM04944XX	40.00	56.00	9.0 / 12.5	TC901A
SOM07172	40.00	49.60	5.50	TC	SOM02101	40.00	57.15	10.00	SB
SOM15540	40.00	50.00	4.00	VB	SOM11052XX	40.00	58.00	8.80	TC04L
SOM17628	40.00	50.00	4.00	VC	SOM01115	40.00	58.00	10.00	SC
SOM10801	40.00	50.00	5.00	VC	SOM01116	40.00	58.00	10.00	TC
SOM08874	40.00	50.00	7.00	TC	SOM01116XX	40.00	58.00	10.00	TC
SOM05277	40.00	52.00	6.00	TC40	SOM11667XX	40.00	58.00	11.30	TCIY
SOM15514	40.00	52.00	6.00	TCR	SOM09051	40.00	58.00	12.30	TCVWY
SOM17044	40.00	52.00	6.00	TCR	SOM15264	40.00	58.00	7.0 / 8.0	TC7Y
SOM01087	40.00	52.00	7.00	SC	SOM09029	40.00	60.00	7.00	SB
SOM01087XX	40.00	52.00	7.00	SC	SOM01123	40.00	60.00	10.00	TC
SOM01089	40.00	52.00	7.00	TC	SOM03552	40.00	60.00	10.00	SBR
SOM17637XX	40.00	52.00	7.00	TCR	SOM11764	40.00	60.00	10.00	TCVR
SOM11689	40.00	52.00	7.00	SCW	SOM11764XX	40.00	60.00	10.00	TCVR
SOM11761	40.00	52.00	7.00	SC	SOM11011	40.00	62.00	6.00	TC
SOM11761XX	40.00	52.00	7.00	SC	SOM08055	40.00	62.00	6.50	TC
SOM15263	40.00	52.00	7.00	TCV	SOM01126	40.00	62.00	7.00	SC
SOM01090	40.00	52.00	8.00	TC	SOM01128	40.00	62.00	7.00	TC
SOM01090XX	40.00	52.00	8.00	TC	SOM17877	40.00	62.00	8.00	DC
SOM09375	40.00	52.00	8.00	TB1	SOM01130	40.00	62.00	10.00	SC
SOM02958	40.00	52.00	9.00	TC	SOM01131	40.00	62.00	10.00	TC
SOM17769XX	40.00	52.00	9.00	TC303	SOM07307	40.00	62.00	11.50	SC

As the new tools adding continuously, please contact with our sales person for the newest tool list.

MFC OIL SEAL STANDARD SIZE LIST

【METRIC】

ITEM NO.	ID	OD	H	TYPE	ITEM NO.	ID	OD	H	TYPE
SOM01136	40.00	62.00	12.00	TC	SOM15394XX	42.00	56.00	7.00	TC3VR
SOM04933XX	40.00	62.00	8.0 / 11.5	TC9R	SOM02681	42.00	56.00	10.00	TC
SOM05543	40.00	63.50	12.70	TC	SOM04408XX	42.00	56.15	7.00	SCVR
SOM01142	40.00	65.00	10.00	TC	SOM09876	42.00	58.00	8.00	TCVR
SOM16969	40.00	65.00	12.00	TB	SOM05042XX	42.00	58.00	9.50	TCL
SOM04932XX	40.00	66.00	8.0 / 11.5	TC9R	SOM01187	42.00	58.00	10.00	TC
SOM01146	40.00	68.00	10.00	SC	SOM01189	42.00	60.00	7.00	TC
SOM02539	40.00	68.00	10.00	TC	SOM04812	42.00	60.00	7.00	TCR
SOM05714	40.00	68.00	11.00	TB1	SOM04812XX	42.00	60.00	7.00	TCR
SOM16979	40.00	68.00	12.00	SC	SOM01192	42.00	60.00	9.00	TC
SOM12096	40.00	70.00	12.00	TC	SOM04811	42.00	60.00	9.00	TCR
SOM16963	40.00	70.00	12.00	SA1	SOM02060	42.00	60.00	10.00	TC
SOM01152	40.00	72.00	10.00	SC	SOM07619	42.00	62.00	6.00	SC
SOM16974	40.00	72.00	12.00	TB	SOM01197	42.00	62.00	7.00	TC
SOM10686	40.00	72.00	6.0 / 7.0	TC7	SOM11769XX	42.00	62.00	7.00	TC24R
SOM04939XX	40.00	76.00	9.0 / 12.5	TC901R	SOM01199	42.00	62.00	8.00	SC
SOM04941XX	40.00	76.00	9.0 / 12.5	TC901L	SOM01200	42.00	62.00	8.00	TC
SOM01158	40.00	80.00	10.00	SC	SOM16716	42.00	62.00	8.00	SCVR
SOM01159	40.00	80.00	10.00	TC	SOM16716XX	42.00	62.00	8.00	SCVR
SOM02337	40.00	80.00	12.00	TC	SOM01203	42.00	62.00	10.00	TC
SOM17100	40.00	52.0/58.5	10.00	TBJ02	SOM05839	42.00	62.50	5.00	OKC3V
SOM08271	40.00	52.0/62.0	6.0 / 8.5	TC40	SOM05375	42.00	65.00	10.00	TC
SOM03140	41.00	53.00	7.00	TA	SOM05331	42.00	65.00	12.00	TBR
SOM03140XX	41.00	53.00	7.00	TA	SOM07338	42.00	65.00	12.00	TBFR
SOM04623	41.00	55.00	6.00	TB	SOM05057XX	42.00	66.00	6.00	TC24R
SOM08801	41.10	49.30	6.20	TBF	SOM09057	42.00	66.00	6.00	TC24R
SOM16957	41.30	66.50	12.70	SA1	SOM09057XX	42.00	66.00	6.00	TC24R
SOM04170XX	42.00	52.00	8.00	TBF	SOM09473	42.00	66.00	6.00	TC24RY
SOM11850	42.00	53.00	7.00	TCVR	SOM07140	42.00	66.00	8.00	TC
SOM11850XX	42.00	53.00	7.00	TCVR	SOM01210	42.00	72.00	8.00	SC
SOM01174XX	42.00	55.00	7.00	TB	SOM02538	42.00	72.00	8.00	TC
SOM01175	42.00	55.00	7.00	TC	SOM15265	42.00	72.00	8.00	SCV
SOM05070	42.00	55.00	7.00	TBZ	SOM01211	42.00	72.00	10.00	SC
SOM05074XX	42.00	55.00	7.00	SB03	SOM02678	42.00	72.00	10.00	TB
SOM16810	42.00	55.00	7.00	KC1	SOM01212	42.00	72.00	10.00	TC
SOM16812	42.00	55.00	7.00	KC1	SOM04575XX	43.00	54.00	7.50	TC
SOM01176	42.00	55.00	8.00	SC	SOM10965XX	43.00	55.00	7.50	KC
SOM01177	42.00	55.00	8.00	TC	SOM02051	43.00	59.00	7.00	TB
SOM02041	42.00	55.00	9.00	TCR	SOM05619	43.00	63.50	7.00	TC
SOM07020	42.00	55.00	9.00	TB3	SOM11225	43.50	68.00	12.00	TC
SOM09007	42.00	55.00	10.00	SC	SOM10084	44.00	54.00	4.50	SC
SOM01181	42.00	56.00	7.00	SC	SOM10626	44.00	57.20	8.50	TBR
SOM01182	42.00	56.00	7.00	TC	SOM07091	44.00	60.00	7.00	TCR
SOM03564	42.00	56.00	7.00	SB	SOM07091XX	44.00	60.00	7.00	TCR
SOM04513XX	42.00	56.00	7.00	SCR	SOM01217	44.00	60.00	10.00	SC
SOM07356XX	42.00	56.00	7.00	TB	SOM05320	44.00	62.00	8.0 / 14.0	TBU03
SOM15394	42.00	56.00	7.00	TC3VR	SOM01220	44.00	62.00	10.00	TC

As the new tools adding continuously, please contact with our sales person for the newest tool list.

MFC OIL SEAL STANDARD SIZE LIST

【METRIC】

ITEM NO.	ID	OD	H	TYPE	ITEM NO.	ID	OD	H	TYPE
SOM05107XX	44.00	62.00	10.00	TCL	SOM10847XX	45.00	65.00	6.0 / 7.5	TCNY
SOM04930XX	44.00	68.00	8.00	SCL	SOM01263	45.00	65.00	8.00	TC
SOM04931XX	44.00	68.00	8.00	SCR	SOM01264	45.00	65.00	10.00	SC
SOM05541	44.00	70.00	12.00	TC	SOM01265	45.00	65.00	10.00	TC
SOM11543	44.00	79.90	12.00	SC	SOM03637	45.00	65.00	10.00	SB
SOM12403	44.00	79.90	12.00	SB1	SOM05715	45.00	65.00	10.00	TCL
SOM09217	44.00	92.00	10.00	TC	SOM07023	45.00	65.00	10.00	TB1
SOM04414	44.50	62.00	10.00	SC	SOM02052	45.00	65.00	12.00	TB
SOM09273	44.50	62.00	10.00	TC	SOM15515	45.00	66.90	9.50	SC
SOM11554	44.50	68.20	15.90	TC	SOM17449XX	45.00	68.00	8.0 / 18.0	TA16
SOM16937	44.50	69.80	12.70	TA	SOM01270	45.00	68.00	12.00	TC
SOM16939	44.50	73.00	12.00	SA1	SOM07419	45.00	68.00	12.00	TC
SOM02383	44.70	59.80	6.50	SB04B	SOM16048	45.00	68.00	12.00	TC3
SOM07216	44.70	59.80	6.50	SB	SOM05261	45.00	68.00	12.5 / 19.0	TC9
SOM08184	45.00	52.00	5.00	VC	SOM01274	45.00	70.00	12.00	TC
SOM17629	45.00	55.00	4.00	VC	SOM16952	45.00	70.00	16.00	TC
SOM04166XX	45.00	55.00	6.00	TBF	SOM01278	45.00	72.00	8.00	TC
SOM01230	45.00	55.00	7.00	SC	SOM01280	45.00	72.00	10.00	TC
SOM07141	45.00	57.00	9.00	TC	SOM05332	45.00	72.00	10.00	TB
SOM17241	45.00	58.00	4.00	VC	SOM09434	45.00	72.00	10.00	TB1
SOM01233	45.00	58.00	7.00	TC	SOM01285	45.00	72.00	12.00	TC
SOM01234	45.00	58.00	7.00	TB	SOM17759XX	45.00	72.00	15.00	TC
SOM01236	45.00	60.00	7.00	SC	SOM01291	45.00	75.00	10.00	TC
SOM01237	45.00	60.00	7.00	TC	SOM09443	45.00	75.00	12.00	TB1R
SOM01238	45.00	60.00	8.00	SC	SOM05716	45.00	78.00	11.0 / 18.0	TB902R
SOM01239	45.00	60.00	8.00	TC	SOM01293	45.00	80.00	10.00	SC
SOM09444	45.00	60.00	8.00	TCVI	SOM05260	45.00	80.00	10.0 / 16.0	TC9
SOM17773XX	45.00	60.00	9.00	TC69VR	SOM02792	45.00	82.00	7.00	SC
SOM01240	45.00	60.00	9.00	TC	SOM02735	45.00	65.0/70.0	10.00	SC15R
SOM01242	45.00	60.00	10.00	SC	SOM10275	45.00	62.0/68.3	10.00	TCY
SOM02061	45.00	60.00	10.00	TC	SOM05954	46.00	58.00	7.00	TC
SOM01246	45.00	62.00	7.00	SC	SOM05108XX	46.00	63.00	7.5 / 8.5	TC7R
SOM01247	45.00	62.00	7.00	TC	SOM07142	46.00	64.00	8.00	TC
SOM05279	45.00	62.00	7.0 / 9.0	SPI8	SOM17113	46.00	69.40	11.0 / 15.0	TC
SOM01250	45.00	62.00	8.00	SC	SOM17099XX	46.00	92.00	5.00	VBY
SOM01251	45.00	62.00	8.00	TC	SOM17741XX	46.00	92.40	5.00	VBY
SOM01254	45.00	62.00	9.00	TC	SOM05718	46.00	94.40	8.0 / 10.0	SCJ02VD
SOM05352	45.00	62.00	9.00	TBF	SOM16965	46.30	66.60	6.40	SB1
SOM01255	45.00	62.00	10.00	SB	SOM15495	47.00	64.00	12.00	TBJR
SOM01256	45.00	62.00	10.00	SC	SOM11002	47.00	65.00	5.00	KB1
SOM01257	45.00	62.00	10.00	TC	SOM17066	47.00	66.50	11.00	KCVY
SOM16942	45.00	62.00	10.00	TC	SOM17164	47.00	70.00	9.00	SAJ01R
SOM17758XX	45.00	62.00	10.00	TC3	SOM02235	47.50	70.60	9.00	TC3
SOM03512	45.00	62.00	12.00	TC	SOM05097	47.60	70.60	13.50	TBF3
SOM15256	45.00	62.00	14.00	DC	SOM15587XX	47.60	73.10	9.70	TC7Y
SOM04681XX	45.00	64.00	9.00	TC	SOM16984	47.70	65.00	8.00	SC
SOM08249XX	45.00	65.00	5.00	VBF	SOM04169XX	48.00	60.00	8.00	TBF

As the new tools adding continuously, please contact with our sales person for the newest tool list.

MFC OIL SEAL STANDARD SIZE LIST

【METRIC】

ITEM NO.	ID	OD	H	TYPE	ITEM NO.	ID	OD	H	TYPE
SOM01307	48.00	62.00	7.00	TC	SOM10443	50.00	62.00	5.00	VCV
SOM08262	48.00	62.00	7.00	TB	SOM01338	50.00	62.00	7.00	SC
SOM17114	48.00	62.00	7.0 / 10.0	TCJ01	SOM04572	50.00	62.00	7.00	SB
SOM01308	48.00	62.00	8.00	SC	SOM01983	50.00	62.00	10.00	SB
SOM01309	48.00	62.00	8.00	TC	SOM01343	50.00	65.00	8.00	SC
SOM17598	48.00	62.00	9.00	TBF	SOM01345	50.00	65.00	8.00	TC
SOM05355	48.00	62.00	8.0 / 13.0	TC9	SOM15274	50.00	65.00	8.00	SCV
SOM03150	48.00	62.00	9.0 / 24.0	KC301	SOM15352	50.00	65.00	8.00	TCL
SOM03150XX	48.00	62.00	9.0 / 24.0	KC301	SOM01346	50.00	65.00	9.00	TC
SOM01311	48.00	62.00	9.00	TB	SOM12419	50.00	65.00	9.50	TB1
SOM03506	48.00	62.00	9.00	TC	SOM05646XX	50.00	65.00	9.55 / 14.0	TB9
SOM17598	48.00	62.00	9.00	TB3F	SOM08397XX	50.00	65.00	9.70	TC9
SOM01313	48.00	62.00	10.00	TC	SOM01348	50.00	65.00	10.00	SC
SOM04407XX	48.00	62.00	10.00	TCJ01	SOM02928	50.00	65.00	10.00	TC
SOM01316	48.00	65.00	7.00	TC	SOM09915	50.00	65.00	10.00	TCVWY
SOM01320	48.00	65.00	10.00	TC	SOM08325	50.00	65.00	10.0 / 14.0	KB9
SOM17174	48.00	65.00	12.00	SA	SOM17242	50.00	67.00	5.00	VC
SOM11521	48.00	65.00	12.00	SB	SOM09454	50.00	67.00	9.00	TB07
SOM17218	48.00	66.10	12.00	SC	SOM05319	50.00	68.00	7.0 / 9.0	TBU02
SOM09247	48.00	68.00	8.00	SB	SOM01987	50.00	68.00	8.00	TC
SOM01323	48.00	68.00	10.00	TC	SOM02362	50.00	68.00	8.00	SC
SOM08555	48.00	68.00	11.00	TCR	SOM10926	50.00	68.00	8.00	TA1
SOM02053	48.00	70.00	10.00	TB	SOM15487XX	50.00	68.00	8.00	TCNY
SOM02187	48.00	70.00	10.00	TC	SOM03145	50.00	68.00	9.00	TA1
SOM01327	48.00	70.00	12.00	TC	SOM07772	50.00	68.00	9.00	TCR
SOM03102	48.00	70.00	12.00	TCR	SOM01354	50.00	68.00	10.00	SC
SOM01329	48.00	72.00	7.00	TC	SOM01355	50.00	68.00	10.00	TC
SOM07380	48.00	72.00	8.00	TC	SOM11770XX	50.00	68.00	10.00	TC24R
SOM05353	48.00	72.00	8.50	TC	SOM17045	50.00	68.00	10.00	SCVR
SOM05123	48.00	72.00	10.00	TC	SOM03254XX	50.00	70.00	7.20	TB
SOM01332	48.00	72.00	12.00	TC	SOM16812	50.00	70.00	9.00	SB
SOM04535	48.00	72.50	10.00	TC	SOM03574XX	50.00	70.00	9.00	SB
SOM05354	48.00	74.00	10.00	TC	SOM04998	50.00	70.00	9.00	TB
SOM02622	48.00	80.00	10.00	TC	SOM03146	50.00	70.00	9.00	SB03
SOM07143	48.00	82.00	12.00	TBR	SOM17681XX	50.00	70.00	10.00	SCVR
SOM09420	48.00	85.00	10.00	TC	SOM01360	50.00	70.00	10.00	TC
SOM17651XX	48.70	63.50	9.50	TCR	SOM09447	50.00	70.00	10.00	TC04L
SOM09054	48.90	63.00	10.8 / 12.8	TCVY	SOM05669	50.00	70.00	11.00	TC
SOM16960	49.00	65.00	10.00	TB	SOM01362	50.00	70.00	12.00	TC
SOM11549	49.00	68.00	12.00	TB1	SOM02002	50.00	72.00	8.00	TC
SOM09248	49.00	63.5/79.5	8.50	KBJ	SOM15653	50.00	72.00	8.00	SA
SOM16938	49.20	80.90	11.00	TA	SOM01366	50.00	72.00	10.00	SC
SOM11224	49.50	77.00	12.00	TC	SOM01367	50.00	72.00	10.00	TC
SOM08197XX	50.00	58.00	4.00	VBF	SOM01369	50.00	72.00	12.00	TC
SOM17016	50.00	60.00	7.00	TC	SOM05542	50.00	76.00	12.00	TC
SOM03128	50.00	60.00	8.00	TC	SOM01376	50.00	80.00	8.00	SC
SOM12464	50.00	62.00	4.00	VB1	SOM01377	50.00	80.00	8.00	TC

As the new tools adding continuously, please contact with our sales person for the newest tool list.

MFC OIL SEAL STANDARD SIZE LIST

【METRIC】

ITEM NO.	ID	OD	H	TYPE	ITEM NO.	ID	OD	H	TYPE
SOM15269	50.00	80.00	8.00	SCVL	SOM16983	54.10	73.00	8.50	TB
SOM01378	50.00	80.00	10.00	SC	SOM09915	55.00	63.50	8.00	TCVWY
SOM01379	50.00	80.00	10.00	TC	SOM01419	55.00	68.00	8.00	SC
SOM03578	50.00	80.00	10.00	SB	SOM03255	55.00	68.00	8.50	TC
SOM01380	50.00	80.00	12.00	TC	SOM03255XX	55.00	68.00	8.50	TC
SOM01385	50.00	85.00	10.00	SC	SOM02063	55.00	68.00	10.00	TC
SOM01386	50.00	85.00	10.00	TC	SOM04409XX	55.00	70.00	6.00	TC9
SOM01390	50.00	90.00	10.00	TC	SOM01424	55.00	70.00	8.00	SB
SOM07148	50.00	90.00	13.00	TC	SOM01425	55.00	70.00	8.00	SC
SOM16954	50.80	79.90	10.00	SB1	SOM01426	55.00	70.00	8.00	TC
SOM16951	50.80	80.00	12.70	SA1	SOM09450	55.00	70.00	8.00	TC04R
SOM16945	50.80	81.00	11.90	TA	SOM17041	55.00	70.00	8.00	TCVR
SOM16936	50.80	115.90	14.30	TB	SOM17041XX	55.00	70.00	8.00	TCVR
SOM08198XX	51.00	58.00	4.00	VBF	SOM01430	55.00	70.00	10.00	TC
SOM05146XX	52.00	63.00	6.00	KB	SOM17053	55.00	70.00	12.00	SCV
SOM08748	52.00	65.00	9.00	TB	SOM10244	55.00	72.00	6.0 / 7.0	TCY
SOM04411XX	52.00	67.00	6.7 / 8.0	OTC07	SOM15270	55.00	72.00	8.00	SCV
SOM08255XX	52.00	68.00	7.0 / 13.0	KC9	SOM01433	55.00	72.00	8.00	TC
SOM05438	52.00	68.00	8.00	TC	SOM01435	55.00	72.00	10.00	SC
SOM05854	52.00	68.00	10.00	TCR	SOM01437	55.00	72.00	10.00	TC
SOM08671	52.00	68.00	13.00	TC	SOM02862	55.00	72.00	10.00	SB
SOM01400XX	52.00	70.00	9.00	TC	SOM04441	55.00	75.00	8.00	TC
SOM02952	52.00	70.00	10.00	TC	SOM01438	55.00	75.00	10.00	SC
SOM17296	52.00	72.00	7.00	TCNY	SOM01439	55.00	75.00	10.00	TC
SOM05717	52.00	72.00	7.50	TB3	SOM03022	55.00	75.00	12.00	SB
SOM01980	52.00	72.00	8.00	TC	SOM01441	55.00	75.00	12.00	TC
SOM01403	52.00	72.00	10.00	TC	SOM04360	55.00	78.00	8.00	SC
SOM07147	52.00	75.00	10.00	TC	SOM17834	55.00	78.00	10.00	SC
SOM16010	52.00	80.00	8.00	TCVR	SOM07129	55.00	78.00	10.00	TC
SOM01407	52.00	80.00	10.00	SC	SOM15266	55.00	80.00	8.00	TCV
SOM01410	52.00	85.00	10.00	SC	SOM01450	55.00	80.00	10.00	TC
SOM03212	52.00	85.00	10.00	TC	SOM09451	55.00	80.00	10.00	TA
SOM04091XX	52.00	100.50	9.00	OSC02	SOM01452	55.00	80.00	12.00	TC
SOM16967	52.40	76.20	7.90	TB	SOM07875	55.00	80.00	12.00	TC
SOM08022	53.00	68.00	10.00	TB	SOM16798XX	55.00	81.00	11.00	SA25
SOM07149	53.00	68.00	13.00	TC	SOM07955	55.00	82.00	10.00	VB
SOM16964	53.00	75.00	12.00	SA1	SOM03305	55.00	85.00	8.00	TC
SOM15211XX	53.10	72.00	10.80	VC9Y	SOM01457	55.00	85.00	10.00	TC
SOM03576XX	54.00	65.00	13.00	TB	SOM01458	55.00	85.00	13.00	SC
SOM07150	54.00	70.00	10.00	TC	SOM16966	55.00	90.00	12.50	SA1
SOM02967	54.00	72.00	10.00	TC	SOM16980	55.00	100.00	12.70	SC
SOM15307	54.00	73.00	9.0 / 10.5	TC7	SOM08256XX	56.00	72.00	9.80	KB9
SOM11712XX	54.00	73.00	12.70	SB	SOM02054	56.00	73.10	9.50	TB
SOM05547	54.00	76.20	8.00	TB	SOM03160	56.00	85.00	13.00	TC
SOM10727	54.00	77.80	12.70	SC	SOM02202	57.00	72.00	9.00	TB
SOM07151	54.00	80.00	10.00	TC	SOM02231	57.00	73.00	7.00	OSC
SOM1772XX	54.00	80.00	12.00	TBZ02	SOM05548	57.00	76.20	10.00	TA1

As the new tools adding continuously, please contact with our sales person for the newest tool list.

MFC OIL SEAL STANDARD SIZE LIST

【METRIC】

ITEM NO.	ID	OD	H	TYPE	ITEM NO.	ID	OD	H	TYPE
SOM05462	57.00	77.00	10.00	TCR	SOM01528	60.00	90.00	10.00	SC
SOM05550	57.00	85.20	8.00	SC	SOM01953	60.00	90.00	10.00	TC
SOM05599	57.00	90.00	13.00	SB	SOM01953XX	60.00	90.00	10.00	TC
SOM10844XX	57.10	76.20	9.5 / 11.0	TCNY	SOM09445	60.00	90.00	13.00	TAIY
SOM17775XX	57.20	76.20	12.70	TCR	SOM10736	60.00	90.00	14.0 / 16.3	SAY
SOM16989	57.20	92.00	18.00	TA	SOM02166	60.00	95.00	10.00	TC
SOM05048	57.30	76.20	12.70	TC	SOM08997	60.00	110.00	12.00	TC
SOM01478	58.00	72.00	8.00	TC	SOM02167	60.00	110.00	13.00	TC
SOM05281	58.00	74.00	10.00	TC15L	SOM16946	60.30	92.00	12.00	TB
SOM01482	58.00	80.00	8.00	SC	SOM09250	62.00	78.00	5.50	TB1
SOM01483	58.00	80.00	10.00	TC	SOM07950	62.00	80.00	12.00	TC3VL
SOM02971	58.00	80.00	10.00	SC	SOM05072XX	62.00	85.00	8.0 / 10.0	TA108
SOM01487	58.00	80.00	13.00	TC	SOM00814	62.00	85.00	10.00	TC
SOM17685	58.00	87.00	7.00	OVC03	SOM04534	62.00	85.00	10.00	TC
SOM04418XX	58.00	90.00	11.00	SC	SOM08892	62.00	85.00	10.00	TC
SOM16949	59.50	85.60	12.00	SA1	SOM10415	62.00	85.00	13.00	SC
SOM17223XX	60.00	68.00	5.00	KC	SOM08789	62.00	90.00	13.00	SB
SOM04104	60.00	72.00	7.50	TB	SOM17402	62.00	93.00	12.00	TB
SOM03173	60.00	72.00	8.00	SC	SOM02067	62.00	95.00	12.00	TC
SOM01497	60.00	75.00	8.00	SC	SOM05788XX	62.50	85.00	9.0 / 11.0	TA109
SOM01498	60.00	75.00	8.00	TC	SOM10802	63.00	80.00	8.00	TB
SOM11928	60.00	75.00	8.00	SCX	SOM07004	63.00	80.00	9.00	TC
SOM16161	60.00	75.00	8.0 / 9.0	TC7	SOM07876	63.00	80.00	10.00	TC
SOM05432	60.00	75.00	10.00	TC	SOM02161	63.00	85.00	10.00	SC
SOM17768	60.00	75.00	10.00	TCR	SOM02255	63.00	90.00	10.00	TC
SOM17633XX	60.00	75.00	10.00	KC10	SOM08440	63.00	100.00	10.00	SC
SOM01507	60.00	80.00	8.00	SC	SOM12068	63.50	82.70	13.60	SB1
SOM01508	60.00	80.00	8.00	TC	SOM16972	63.50	110.00	13.00	SA1
SOM05179	60.00	80.00	8.00	TCL	SOM02702	64.00	80.00	8.00	SBL
SOM08247XX	60.00	80.00	9.00	TB	SOM03561	64.00	80.00	8.00	TC
SOM01510	60.00	80.00	10.00	SB	SOM01545	65.00	80.00	8.00	SC
SOM01512	60.00	80.00	10.00	SC	SOM08056	65.00	80.00	9.00	TC
SOM01513	60.00	80.00	10.00	TC	SOM02069	65.00	80.00	10.00	TC
SOM02795Z01	60.00	80.00	12.00	TC	SOM04165XX	65.00	82.00	7.00	KB1
SOM11552	60.00	80.00	12.00	TB1	SOM01547	65.00	85.00	10.00	TC
SOM01516	60.00	80.00	13.00	SB1	SOM01547XX	65.00	85.00	10.00	TC
SOM01518	60.00	82.00	12.00	TC	SOM02181	65.00	85.00	10.00	SB
SOM07392XX	60.00	82.00	12.00	TCL	SOM02181XX	65.00	85.00	10.00	SB
SOM11248XX	60.00	85.00	5.00	AF02	SOM10340	65.00	85.00	10.00	DC01
SOM01520	60.00	85.00	8.00	SC	SOM01549	65.00	85.00	12.00	SC
SOM01521	60.00	85.00	8.00	TC	SOM11249XX	65.00	90.00	5.00	AF02
SOM01522	60.00	85.00	10.00	SC	SOM01538	65.00	90.00	10.00	SC
SOM01523	60.00	85.00	10.00	TC	SOM01556	65.00	90.00	10.00	TC
SOM02823	60.00	85.00	12.00	TC	SOM03584	65.00	90.00	10.00	SB
SOM17285	60.00	85.00	13.00	SC	SOM01559	65.00	90.00	12.00	TC
SOM02065	60.00	85.00	13.00	TC	SOM01559XX	65.00	90.00	12.00	TC
SOM04116XX	60.00	90.00	8.00	OVC01	SOM05269	65.00	90.00	13.00	TBF

As the new tools adding continuously, please contact with our sales person for the newest tool list.

MFC OIL SEAL STANDARD SIZE LIST

【METRIC】

ITEM NO.	ID	OD	H	TYPE	ITEM NO.	ID	OD	H	TYPE
SOM07654	65.00	90.00	15.00	SBFR	SOM16714	70.00	100.00	12.00	TC
SOM02140	65.00	90.00	13.00	SC	SOM02978	70.00	100.00	13.00	SC
SOM17219	65.00	90.00	15.00	TB	SOM03497	70.00	100.00	13.00	TC
SOM11373	65.00	95.00	10.00	TC	SOM05680	70.00	110.00	12.00	TC
SOM15580	65.00	100.00	8.00	TC	SOM04153XX	70.00	110.00	13.00	TA
SOM01563	65.00	100.00	10.00	SC	SOM01614	70.00	120.00	10.00	TC
SOM02300	65.00	100.00	13.00	SC	SOM07127	71.00	88.00	8.00	TC
SOM11219	65.00	110.00	12.00	SC	SOM17773XX	71.00	106.00	9.00	SP09
SOM01567	65.00	120.00	12.00	SC	SOM04465	72.00	96.00	9.00	TCL
SOM10848XX	66.00	85.00	10.0 / 11.5	TCNY	SOM05720	73.00	90.00	8.00	TB07
SOM17677XX	66.67	89.30	10.00	TCVR	SOM10348	73.00	90.50	12.00	TB1
SOM11537	66.70	95.25	12.70	SC	SOM11711	73.00	92.00	9.50	SC
SOM07448	67.00	80.00	10.00	SBF	SOM16943	73.00	95.20	12.70	SA1
SOM05581	67.00	85.00	10.00	SA	SOM08318XX	73.00	110.00	15.00	TC69
SOM17067	67.00	86.00	9.50	KCVY	SOM09485	74.00	90.00	10.00	SBL
SOM02047	68.00	88.00	10.00	TA1	SOM09485XX	74.00	90.00	10.00	SBL
SOM01571	68.00	90.00	10.00	SC	SOM01624	74.00	98.00	12.00	TC
SOM01573	68.00	90.00	10.00	TC	SOM05733XX	74.00	100.00	13.00	TCR
SOM11532	68.00	90.00	10.00	TB1	SOM11044	74.00	101.50	17.00	TAY
SOM05151	68.00	90.00	12.00	TB	SOM01625	75.00	90.00	8.00	SC
SOM01575	68.00	90.00	13.00	TB	SOM03076	75.00	90.00	10.00	TC
SOM02424	68.00	100.00	10.00	TC	SOM07596XX	75.00	90.00	10.00	OEC02
SOM04158XX	68.00	102.00	10.00	OSC01	SOM16263	75.00	90.00	11.50	TC
SOM05184XX	69.00	112.00	10.0 / 17.5	TC35	SOM16762	75.00	95.00	8.00	TCVL
SOM16947	69.80	95.20	12.70	SA1	SOM01630	75.00	95.00	10.00	TC
SOM01583	70.00	85.00	8.00	TC	SOM15551	75.00	95.00	10.00	TB1
SOM15537	70.00	85.00	8.50	SC	SOM01631	75.00	95.00	12.00	SC
SOM02070	70.00	85.00	10.00	TC	SOM11172	75.00	95.00	13.00	SB1
SOM08396XX	70.00	85.00	16.00	DC01	SOM16827	75.00	95.00	13.00	TCVL
SOM01588	70.00	88.00	12.00	TC	SOM01635	75.00	100.00	10.00	SC
SOM17701XX	70.00	90.00	10.00	TC04R	SOM01636	75.00	100.00	10.00	TC
SOM01590	70.00	90.00	10.00	SC	SOM01636XX	75.00	100.00	10.00	TC
SOM01592	70.00	90.00	10.00	TC	SOM01637	75.00	100.00	12.00	TB
SOM02008	70.00	90.00	10.00	SB	SOM01638	75.00	100.00	12.00	TC
SOM02037	70.00	90.00	10.00	SBL	SOM01638XX	75.00	100.00	12.00	TC
SOM02728	70.00	90.00	10.00	TBL	SOM17131	75.00	100.00	12.00	TA1
SOM09448	70.00	90.00	10.00	TC04R	SOM01642	75.00	100.00	13.00	SC
SOM01594	70.00	90.00	12.00	TC	SOM01644	75.00	100.00	13.00	TC
SOM17135Z01	70.00	90.00	12.0 / 14.5	SPY	SOM04467XX	75.00	100.00	13.00	TCR
SOM09503	70.00	90.00	12.0 / 15.0	SAY	SOM08803XX	75.00	100.00	13.00	TCL
SOM02437	70.00	90.00	13.00	DC	SOM09102	75.00	102.00	12.00	TB
SOM01598	70.00	92.00	12.00	TC	SOM04172XX	75.00	105.00	10.00	TC
SOM01599	70.00	95.00	10.00	SC	SOM03282	75.00	105.00	12.00	TC
SOM02916	70.00	95.00	10.00	TC	SOM04157XX	75.00	105.00	12.00	TA1
SOM01601	70.00	95.00	13.00	TC	SOM04369	75.00	105.00	13.00	SC
SOM01602	70.00	100.00	10.00	SC	SOM04124XX	75.00	105.00	15.00	KC02
SOM01603	70.00	100.00	10.00	TC	SOM02883	75.00	110.00	13.00	TC

As the new tools adding continuously, please contact with our sales person for the newest tool list.

MFC OIL SEAL STANDARD SIZE LIST

【METRIC】

ITEM NO.	ID	OD	H	TYPE	ITEM NO.	ID	OD	H	TYPE
SOM05415	75.00	121.00	13.00	TB	SOM11759	84.00	104.00	11.00	TCVL
SOM15498	75.50	92.00	9.50	TCVL	SOM12163	84.00	104.00	11.00	TCL
SOM10622	76.00	95.45	9.50	TBL	SOM15284	85.00	102.00	13.00	TC
SOM07128	76.00	98.00	12.00	TC	SOM09335	85.00	105.00	8.00	SC
SOM10845XX	76.20	95.20	9.5 / 11.0	TCNY	SOM10256	85.00	105.00	8.00	TC
SOM05721	77.00	102.00	10.0 / 22.0	TA09	SOM09055	85.00	105.00	9.00	TCVL
SOM03494	78.00	100.00	10.00	TC	SOM02719XX	85.00	105.00	10.00	TCL
SOM15283XX	78.00	100.00	10.00	SCL	SOM01691	85.00	105.00	12.00	TC
SOM03563	78.00	100.00	13.00	TC	SOM05273	85.00	105.00	12.00	TC39L
SOM17679XX	79.30	95.20	11.10	TCVL	SOM07387XX	85.00	105.00	12.00	TCVL
SOM08554	80.00	96.00	9.00	TCL	SOM17047	85.00	105.00	12.00	TCVLY
SOM08554XX	80.00	96.00	9.00	TCL	SOM17047XX	85.00	105.00	12.00	TCVLY
SOM17122	80.00	96.00	9.00	TC09	SOM17452	85.00	105.00	12.00	TC24VL
SOM04134	80.00	98.00	10.00	TCL	SOM01694	85.00	105.00	13.00	TC
SOM16715	80.00	98.00	10.00	TCVLY	SOM08238XX	85.00	105.00	12.0 / 13.0	TC7L
SOM17068	80.00	99.00	10.00	KCVY	SOM01695	85.00	110.00	10.00	TC
SOM03003	80.00	100.00	7.00	TC	SOM01697	85.00	110.00	12.00	TC
SOM16174	80.00	100.00	7.50	TCN	SOM04636	85.00	110.00	12.00	TB
SOM15289XX	80.00	100.00	8.00	TC24L	SOM01698	85.00	110.00	13.00	TC
SOM05091	80.00	100.00	8.50	TCL	SOM04161XX	85.00	110.00	13.00	TB3
SOM01655	80.00	100.00	10.00	DC	SOM02209	85.00	120.00	10.00	TC
SOM04343	80.00	100.00	10.00	SB	SOM01700	85.00	120.00	12.00	TC
SOM01658	80.00	100.00	10.00	SC	SOM08063	85.00	120.00	13.00	TC
SOM01659	80.00	100.00	10.00	TC	SOM16934	85.70	119.00	12.70	SA1
SOM01660	80.00	100.00	10.00	TB	SOM16950	88.90	126.90	12.70	TA
SOM04483	80.00	100.00	10.00	TCL	SOM17792XX	89.50	110.00	7.00	TCVLY
SOM17636XX	80.00	100.00	13.00	KC11	SOM17676XX	90.00	104.00	11.00	TC04L
SOM01668	80.00	100.00	13.00	TC	SOM11772XX	90.00	110.00	7.00	TC24L
SOM02043	80.00	100.00	13.00	TCR	SOM17674XX	90.00	110.00	8.50	TCL
SOM04168XX	80.00	100.00	13.00	TA	SOM04486	90.00	110.00	9.00	TCL
SOM05407	80.00	100.00	13.00	TCW	SOM07130	90.00	110.00	10.00	TC
SOM10627	80.00	100.00	13.00	TCVL	SOM17842	90.00	110.00	10.00	TC5
SOM11422XX	80.00	100.00	13.00	SCL	SOM11773XX	90.00	110.00	10.00	TC24L
SOM07181	80.00	105.00	12.00	TC	SOM11854	90.00	110.00	10.00	TCVL
SOM07181XX	80.00	105.00	12.00	TC	SOM11854XX	90.00	110.00	10.00	TCVL
SOM15824XX	80.00	105.00	10.0 / 16.0	KBY	SOM01713	90.00	110.00	12.00	TC
SOM01674	80.00	110.00	12.00	SC	SOM07522	90.00	110.00	12.00	TB
SOM01675	80.00	110.00	12.00	TC	SOM01716	90.00	110.00	13.00	TC
SOM05333	80.00	110.00	12.00	TB1	SOM17678XX	90.00	110.00	13.00	SCVL
SOM02811	80.00	110.00	13.00	TC	SOM07114	90.00	110.00	15.00	TCL
SOM04159XX	80.00	112.00	12.00	OSC	SOM12466	90.00	112.00	12.00	TC
SOM11411	80.00	125.00	10.00	TC	SOM02048	90.00	112.70	13.00	TA1
SOM05613	80.00	140.00	12.00	SC	SOM01722	90.00	115.00	13.00	TC
SOM16711	81.00	117.50	14.30	SC	SOM08287	90.00	115.00	13.00	TB1
SOM04477	82.00	105.00	13.00	TC	SOM09446	90.00	115.00	13.00	TC04L
SOM04662XX	82.00	105.00	13.00	TCJ03	SOM05734XX	90.00	118.00	12.00	TA
SOM07678	82.00	110.00	12.00	SC	SOM02135	90.00	120.00	12.00	SC

As the new tools adding continuously, please contact with our sales person for the newest tool list.

MFC OIL SEAL STANDARD SIZE LIST

【METRIC】

ITEM NO.	ID	OD	H	TYPE	ITEM NO.	ID	OD	H	TYPE
SOM01724	90.00	120.00	13.00	TC	SOM01762	100.00	130.00	12.00	SC
SOM05363	90.00	120.00	13.00	SB	SOM01763	100.00	130.00	12.00	TC
SOM04139	90.00	125.00	12.00	TC	SOM10734	100.00	135.00	10.00	TCL
SOM09120	90.00	125.00	13.00	TC	SOM04163XX	100.00	135.00	15.00	TC20
SOM10809XX	90.00	125.00	15.00	TC68	SOM03784	100.00	140.00	12.00	TC
SOM05215XX	90.00	125.00	16.70	SA39	SOM17001	100.00	150.00	12.00	TC
SOM01978	90.00	130.00	13.00	TC	SOM03801	105.00	125.00	10.00	SC
SOM03423XX	90.00	130.00	15.00	TA	SOM01772	105.00	125.00	13.00	TC
SOM09811	90.00	135.00	12.00	SC	SOM03025	105.00	125.00	13.00	SC
SOM07734	90.00	150.00	12.00	SC25	SOM11927	105.00	130.00	10.00	TC04L
SOM05852	92.00	110.00	10.00	SCL	SOM02131	105.00	130.00	12.00	TC
SOM10849XX	92.00	110.00	9.5 / 11.0	TCNY	SOM03815	105.00	130.00	15.00	TC
SOM15643XX	92.00	114.30	12.00	SA25	SOM02373	105.00	140.00	12.00	SC
SOM08693XX	93.50	110.00	7.00	TCVLY	SOM15658XX	107.00	147.00	13.00	OSC04
SOM02040	95.00	110.00	11.00	TCL	SOM16970	108.00	136.50	12.70	SA1
SOM01734	95.00	115.00	12.00	TC	SOM04152XX	110.00	125.00	8.00	TB1
SOM02704	95.00	115.00	12.00	TCL	SOM17264XX	110.00	130.00	12.70	TBL
SOM05725	95.00	115.00	12.00	TC3	SOM09043	110.00	130.00	13.00	SA1
SOM10255	95.00	115.00	12.00	SCR	SOM02068	110.00	135.00	13.00	TC
SOM09042	95.00	115.00	13.00	SA1	SOM08023	110.00	135.00	13.00	TB
SOM05791	95.00	118.00	10.00	TCL	SOM02146	110.00	140.00	12.00	TC
SOM05791XX	95.00	118.00	10.00	TCL	SOM02101	110.00	140.00	12.00	SC
SOM01945	95.00	120.00	10.00	TC	SOM17844	110.00	145.00	12.00	TCVL
SOM01738	95.00	120.00	12.00	SC	SOM03860	110.00	150.00	13.00	TC
SOM01945XX	95.00	120.00	12.00	TC	SOM07242	110.00	160.00	12.00	TC
SOM15271	95.00	120.00	12.00	SCV	SOM07132	112.00	140.00	13.00	TC
SOM01740	95.00	120.00	13.00	SC	SOM08733	114.00	135.00	13.00	TB
SOM01740XX	95.00	120.00	13.00	SC	SOM07134	114.00	140.00	13.00	TC
SOM17756XX	95.00	120.00	13.00	TBLY	SOM08039	114.00	142 / 154	16.0 / 27.0	SB21
SOM02267	95.00	125.00	12.00	TC	SOM15844	115.00	130.00	12.00	TC
SOM02308	95.00	125.00	13.00	TC	SOM01794	115.00	140.00	12.00	SC
SOM04137	95.00	125.00	13.00	TC	SOM15861XX	115.00	140.00	12.00	SCVW
SOM07131	98.00	116.00	10.00	TC	SOM01796	115.00	140.00	13.00	TC
SOM17150	99.00	119.00	10.00	TBLY	SOM07133	115.00	140.00	15.00	TBL
SOM04160XX	100.00	114.00	7.00	TB1	SOM05736	115.00	140.00	16.00	SCL
SOM09449	100.00	118.00	10.00	TC04L	SOM17262XX	115.00	140.00	16.00	TBL
SOM02220	100.00	120.00	10.00	TC	SOM03187	115.00	150.00	12.00	TC
SOM01749	100.00	120.00	11.00	TC	SOM07135	116.00	160.00	13.00	TC
SOM01753	100.00	120.00	12.00	SC	SOM16948	119.00	162.10	15.00	SC
SOM01754	100.00	120.00	12.00	TC	SOM17830	120.00	140.00	8.50	OKC
SOM02158	100.00	125.00	12.00	TC	SOM02953	120.00	140.00	12.00	TC
SOM02158XX	100.00	125.00	12.00	TC	SOM04162XX	120.00	140.00	12.00	TB3
SOM01760	100.00	125.00	13.00	TC	SOM09045	120.00	140.00	13.00	SA1
SOM03609	100.00	125.00	13.00	TA	SOM10303	120.00	140.00	15.00	TC
SOM04167XX	100.00	125.00	13.00	TA3	SOM03955	120.00	145.00	12.00	TC
SOM17843	100.00	127.00	10.50	TC	SOM01808	120.00	150.00	12.00	SC
SOM03203	100.00	130.00	10.00	SC	SOM02629	120.00	150.00	12.00	TC

As the new tools adding continuously, please contact with our sales person for the newest tool list.

MFC OIL SEAL STANDARD SIZE LIST

【METRIC】

ITEM NO.	ID	OD	H	TYPE	ITEM NO.	ID	OD	H	TYPE
SOM03659	120.00	150.00	12.00	DC	SOM08790	140.00	180.00	15.00	SB
SOM03967	120.00	150.00	13.00	SB	SOM02118	145.00	167.00	13.00	TC
SOM07136	120.00	150.00	15.00	TB	SOM05833	145.00	167.00	13.00	TCV
SOM09105	120.00	160.00	12.00	TB	SOM04252	145.00	170.00	15.00	SB
SOM08059	120.00	160.00	13.00	TC	SOM17201	145.00	180.00	12.00	TC
SOM03180	120.00	160.00	15.00	TC	SOM10343	145.00	180.00	15.00	TC
SOM02354	120.00	160.00	16.00	TC	SOM15173	150.00	164.00	5.00	TCNY
SOM05144XX	122.00	141.00	10.00	SCL	SOM07154	150.00	168.00	15.00	TC
SOM17254XX	122.00	141.00	12.00	SCG	SOM17632XX	150.00	172.00	13.00	KC10
SOM17263XX	122.00	141.00	12.00	SCG	SOM05485	150.00	180.00	12.00	TC
SOM02205	124.00	170.00	14.50	OSC	SOM01864	150.00	180.00	13.00	SA1
SOM04358	125.00	145.00	13.00	OSC	SOM02268	150.00	180.00	15.00	TC
SOM04359	125.00	145.00	13.00	SC	SOM07510	150.00	180.00	15.00	SB
SOM01820	125.00	150.00	12.00	TC	SOM10195	154.00	175.00	13.00	SB
SOM03993	125.00	150.00	13.00	TC	SOM15694XX	155.00	174.00	8.00	TCNY
SOM04141	125.00	150.00	15.00	TC	SOM07006	155.00	174.00	12.00	TC
SOM09103	125.00	150.00	15.00	TB	SOM07643	155.00	180.00	15.00	TC04W
SOM09886	125.00	160.00	10.00	SC	SOM17586XX	157.00	184.00	18.50	TC
SOM17596XX	126.00	140.00	7.00	VB	SOM05000	160.00	180.00	15.00	SA
SOM07152	126.00	146.00	10.00	TC	SOM02616	160.00	180.00	15.00	SC
SOM07343	127.00	150.00	12.00	TCL	SOM15642	160.00	190.00	15.00	TA5
SOM05463	130.00	150.00	10.00	TB	SOM02111	160.00	200.00	15.00	TC
SOM05681	130.00	150.00	13.00	TC	SOM03302	162.00	190.00	12.00	SC
SOM04171XX	130.00	150.00	14.00	TB1	SOM17845	170.00	190.00	13.00	TB
SOM17634XX	130.00	150.00	13.00	KC10	SOM17846	170.00	190.00	13.00	SBX
SOM01836	130.00	160.00	12.00	SC	SOM02921	175.00	200.00	15.00	TC
SOM02075	130.00	160.00	12.00	TC	SOM03421	175.00	200.00	15.00	SB
SOM09104	130.00	160.00	13.00	TB	SOM16625	187.00	39.50	5.00	SC
SOM01838	130.00	160.00	15.00	TC	SOM01896	190.00	220.00	15.00	SC
SOM07658	130.00	160.00	15.00	TCL	SOM02491XX	190.00	220.00	15.00	TB
SOM09070XX	130.00	162.00	15.50	OSC01	SOM02923	190.00	220.00	15.00	TC
SOM01839	130.00	170.00	12.00	SC	SOM17054XX	190.00	220.00	15.00	SB
SOM17265XX	133.00	159.00	13.0 / 15.0	TC7G					
SOM17680XX	133.80	158.90	12.90	TBL					
SOM07943	135.00	160.00	15.00	SB					
SOM01846	135.00	170.00	12.00	SC					
SOM01849	140.00	160.00	12.00	TC					
SOM04142	140.00	160.00	13.00	TC					
SOM02164	140.00	160.00	13.00	SC					
SOM05001	140.00	160.00	13.00	SA					
SOM07153	140.00	160.00	15.00	TC					
SOM07944	140.00	165.00	15.00	SB					
SOM01851	140.00	170.00	12.00	SC					
SOM02535	140.00	170.00	13.00	SC					
SOM01856	140.00	170.00	15.00	TC					
SOM05657	140.00	170.00	15.00	SA1					
SOM01857	140.00	180.00	15.00	TC					

As the new tools adding continuously, please contact with our sales person for the newest tool list.

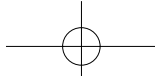

MFC VALVE STEM SEAL STANDARD SIZE LIST

9-5 VALVE STEM SEAL

【METRIC】

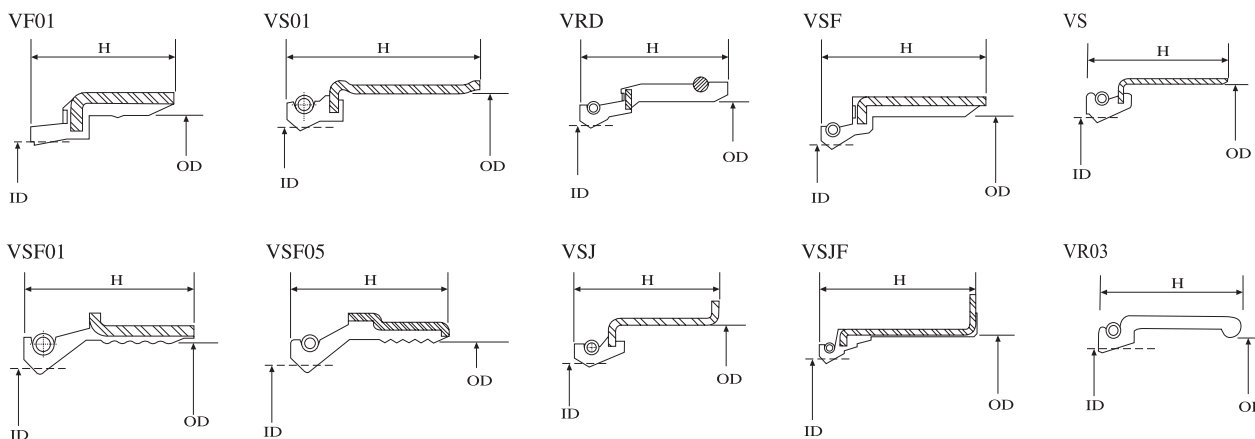

	OEM NO.	ENGINE MODEL	NEW MFC NO.	TYPE
AUDI/VOVLO	0956,22		VSM00177XX	VSF05
CITROEN	027 109 675		VSM00179XX	VSF05
DAIHATSU	90048-12006		VSM00010XX	VS01
FORD		V6, 183(3.0L) SHO ENG 1989-92 V8, 280(4.6L) 1991-94	VSM00115XX2	VSF
FORD		MERCURY 6, 144.170.200.250, 1960-83	VSM00179XX	VSF05
FORD		TRUCK V8/351W(5.8)	VSM00018XX	VSF
GM		CHEVROLET & TRUCK 4 / 140	VSM00018XX	VSF
GM		V6 CILS. 3.1LTS	VSM00281XX	VR01
HONDA	12210-PJ7-003		VSM00128XX	VSF
HONDA	12210-PJ7-004		VSM00129XX	VSF
ISUZU	894110-5590		VSM00282XX	VSF
MAZDA	B630-10-155		VSM00086XX	VS01
MAZDA	HE19-10-155		VSM00243XX	VS
MITSUBISHI	MD000508	1.2 Litre Engine:4G36 1.3 Litre Engine:4G30 1.4 Litre Engine:4G33 1.4 Litre Engine:G33B 1.6 Litre Engine:4G32 1.6 Litre Engine:G32B 1.6 Litre Engine:G32BT 1.8 Litre Engine:4D65 1.8 Litre Engine:4D65T 1.8 Litre Engine:4G37;G37B 1.8 Litre Engine:G62B	VSM00115XX2	VSF
NISSAN	13207-D0111 & D0000	1.2 Litre Engine:12NZ;C12NZ;X12SZ-OHC; 12ST;12NV 1.3 Litre Engine:13NB;13C;13S;13SB-OHC; C13N;C13NB;C13S;C13SB-OHC 1.4 Litre Engine:C14NV;C14NZ;C14LV-OHC; C14SE;X14NZ;X14SZ-OHC	VSM00008XX	VSF
NISSAN	13207-D0100		VSM00009XX	VSF
NISSAN	13207-21002		VSM00013XX	VRD
NISSAN	13207-81W00		VSM00013XX	VRD
NISSAN	13207-H7210		VSM00288XX	VS01
SUZUKI	09289-07005		VSM00100XX	VSF
TOYOTA	90913-02023		VSM00011XX	VSF
TOYOTA	90913-02042	TRUCK 6/F. 2F. 3FE/1976-92	VSM00017XX	VSJ
TOYOTA	90913-02071		VSM00129XX	VSF
TOYOTA	90913-02038		VSM00282XX	VSF
VOLKSWAGEN	026 109 675		VSM00177XX	VSF05
VOLKSWAGEN	0956,22		VSM00177XX	VSF05
VOLKSWAGEN	027 109 275		VSM00179XX	VSF05
	8173-10-155		VSM00014XX	VS01

As the new tools adding continuously, please contact with our sales person for the newest tool list.

MFC S11&S50 STANDARD SIZE LIST

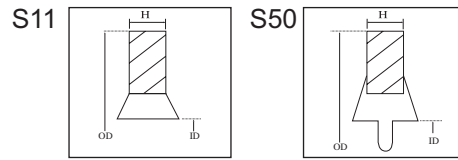

【METRIC】

9-6 BONDED SEAL (S11)

THREAD DIA		MFC NO.	OD	ID	H
INCH	M				
6BA		S11001	6.35	3.05	1.20
4BA		S11002	7.26	4.12	1.20
2BA		S11003	8.38	5.21	1.20
1/4		S11004	13.21	6.86	1.20
1/4		S11005	13.34	6.99	1.20
5/16		S11006	13.34	8.31	1.20
5/16		S11007	14.22	8.64	1.20
3/8		S11020	15.88	10.37	2.00
.40		S11008	18.36	11.26	2.00
7/16		S11009	19.05	11.69	2.00
1/2	1/4	S11021	20.57	13.74	2.00
9/16		S11010	22.23	14.86	2.00
.60		S11022	22.23	15.83	2.00
5/8		S11011	25.40	16.51	2.00
	3/8	S11023	23.80	17.28	2.00
11/16		S11012	25.40	18.16	2.30
3/4		S11024	26.92	19.69	2.30
13/16	1/2	S11025	28.58	21.54	2.30
7/8	5/8	S11026	31.75	23.49	2.30
15/16		S11013	33.27	24.26	2.30
1	3/4	S11027	34.93	27.05	2.30
1 1/16		S11028	38.61	27.82	2.30
1 1/8		S11014	36.58	29.33	2.50
1 3/16	7/8	S11029	38.10	30.81	2.30
1 1/4		S11015	41.40	32.64	3.20
1 5/16	1	S11030	42.80	33.89	3.20
1 5/16	1	S11031	42.80	33.89	3.20
1 3/8		S11016	44.45	38.96	2.30
1 1/2		S11017	47.75	45.34	3.20
1 5/8	1 1/4	S11032	52.38	42.93	3.20
1 3/4		S11018	57.15	45.34	3.20
1 7/8	1 1/2	S11033	58.60	48.44	3.20
2		S11019	63.50	51.69	3.20
2 1/8	1 3/4	S11034	69.85	54.89	3.20
2 1/4		S11035	70.36	58.04	3.20
	2	S11036	73.03	60.58	3.20
2 1/2		S11037	77.72	64.39	3.20
	2 1/4	S11038	79.50	66.68	3.20
	2 1/2	S11039	90.30	76.08	3.20

9-7 BONDED SEAL (S50)

BSP THREAD SIZE DIAMETER M	MFC NO.	OD	ID	H
1/8	S50020	15.88	10.37	2.00
1/4	S50021	20.57	13.74	2.00
3/8	S50023	23.80	17.28	2.00
1/2	S50025	28.58	21.54	2.30
5/8	S50026	31.75	23.49	2.30
3/4	S50027	34.93	27.05	2.30
7/8	S50029	38.10	30.81	2.30
1	S50030	38.89	42.80	3.20
1 1/4	S50032	52.38	42.93	3.20
1 1/2	S50033	58.60	48.44	3.20
1 3/4	S50034	69.85	54.89	3.20
2	S50036	73.03	60.58	3.20
2 1/4	S50038	79.50	66.68	3.20
2 1/2	S50039	90.17	76.08	3.20

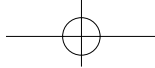

M.F.C.ENGINEERING INFORMATION SHEET (OIL SEAL)

CUSTOMER & DIVISION		<p style="text-align: center;">FILL BLANK WITH SIZE. UNIT:mm. or inch</p>		
CONTACT				
MFC P/N				
CUSTOMER P/N				
APPLICATION & TYPE OF EQUIPMENT				
SHAFT	<input type="checkbox"/> HORIZONTAL <input type="checkbox"/> VERTICAL	MATERIAL :	ROUGHNESS :	SHAFT INSTALLATION DIRECTION:
BORE	MATERIAL :	INSTALLATION DIRECTION INTO BORE :		
MOTION	<input type="checkbox"/> ROTATING	RPM : ● NORMAL ● MAX		
	<input type="checkbox"/> RECIPROCATING	RMUNOUT : TIR		
	<input type="checkbox"/> OSCILLATING	STROKE LENGTH :		
		CYC/MIN :		
MEDIUM TO BE SEALED		IN	● TYPE	● LEVEL <input type="checkbox"/> FLOODED <input type="checkbox"/> MIST <input type="checkbox"/> DRY
		OUT	● TYPE	
TEMP	<input type="checkbox"/> ° F <input type="checkbox"/> ° C ● MINIMUM ● NORMAL ● MAX			
PRESS	<input type="checkbox"/> PSI <input type="checkbox"/> kPa <input type="checkbox"/> other ● NORMAL ● MAX			
AUTOMATED ASSBLY		<input type="checkbox"/> YES		
		<input type="checkbox"/> NO		
LEAKAGE CONDITION AND TIME :				